

Special Shapes



Acme Brick Company

Introduction

Historically, Acme Brick Company has encouraged building design that utilizes special shapes. Brick shapes allow architects to design buildings with interesting angles and forms. Dramatic depth and shadows in openings can be attained by using brick shapes at angle corners and in deep reveals at soffits, lintels, and sills.

Innovative uses of brick in load-bearing brick structures and conventional brick construction has resulted in brick buildings which are often exciting expressions in architectural design. Acme Brick Company's objective is to manufacture brick shapes which will assist architects in designing more functional and aesthetically pleasing buildings at the most economical cost.



This dramatic alcove was built in 1940, and adorns the SMU campus in Dallas, Texas.

Selection



All shapes illustrated in this brochure are shown in modular brick dimensions ($3\frac{5}{8}$ " x $2\frac{1}{4}$ " x $7\frac{5}{8}$ "), and in two shades of red. The lighter red indicates an exposed face. Shapes to perform similar functions with other brick sizes, such as Acme's King Size (3 " x $2\frac{5}{8}$ " x $9\frac{5}{8}$ ") and Acme's Utility Size ($3\frac{5}{8}$ " x $3\frac{5}{8}$ " x $11\frac{5}{8}$ ") units are available for manufacture. Special brick shapes shown are typical, and variations of shapes for a particular use can often be manufactured.

Color and Texture



Acme Brick offers a wide variety of colors and textures in special shape brick by manufacturing shapes at four architectural brick plants: Denton (Texas), Elgin (Texas), Perla (Arkansas), and Tulsa (Oklahoma).

The color and texture of special shape brick is intended to be as close as possible to that of the standard stretcher brick, but is subject to normal limitations of manufacture. Some brick shapes cannot be stacked for firing in the kiln in the same direction as the field brick. This can cause a variation in kiln atmosphere at high temperatures which may produce a slight color difference. Close inspection of certain shapes may disclose a texture difference, as some shapes have to be made by hand to accompany brick that are made mechanically.

Ordering

Special shape brick are considered a custom made item. They are manufactured to order for a specific project. Manufacturing cannot begin until an order has been placed for firm quantities, and shape drawings have been approved.

To eliminate errors and to facilitate estimating quantities, Acme Brick Company will provide, from architectural plans, drawings of each shape showing the plan, elevations, and dimensions for each shape. All exposed brick faces will be clearly identified, and the coring of the unit will be shown. Brick coursing will be indicated in the areas where shapes are used. Upon completion the architect will receive these drawings for final inspection and approval. Your Acme Brick Sales Representative is qualified to help you with planning shapes for your next project.

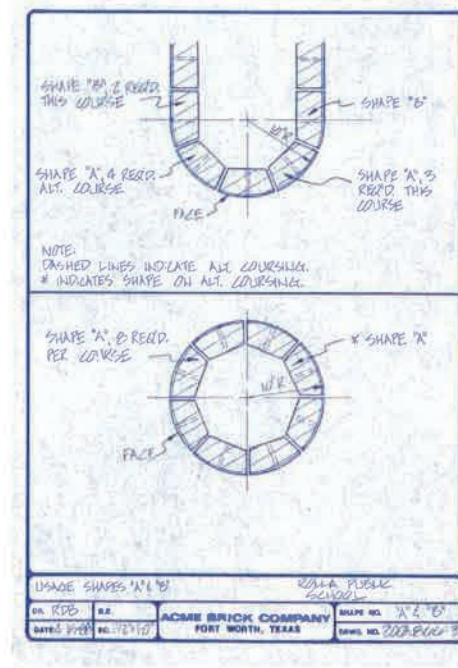
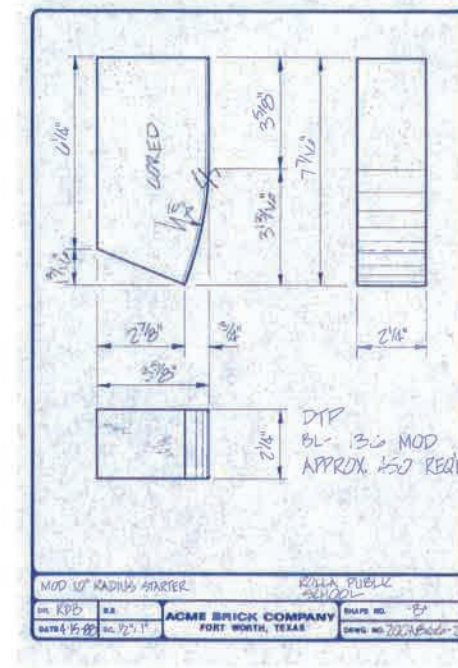
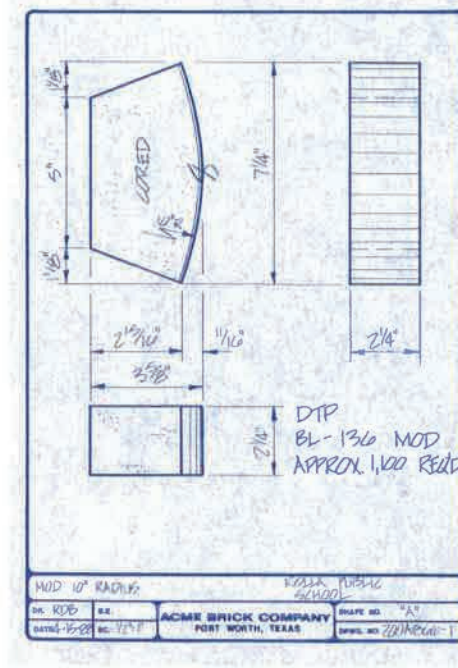

Angles

AN-1 Short Corner

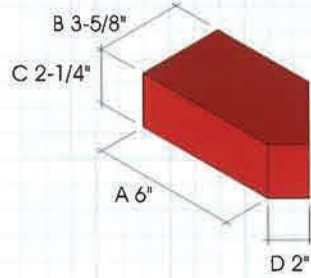
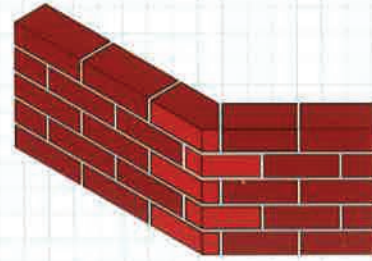

AN-2 Long Corner

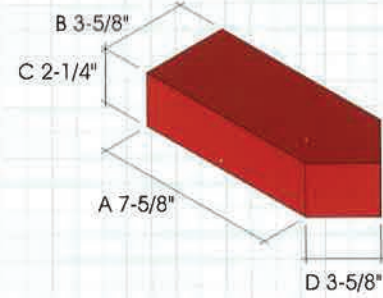
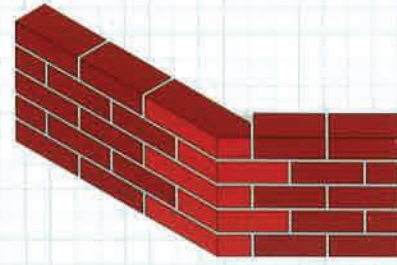

AN-3 Internal Corner

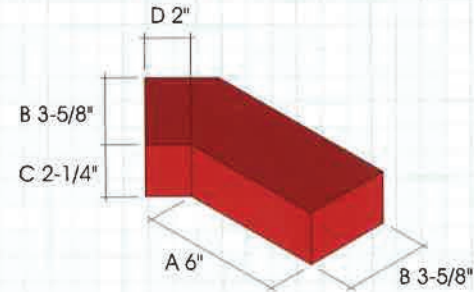
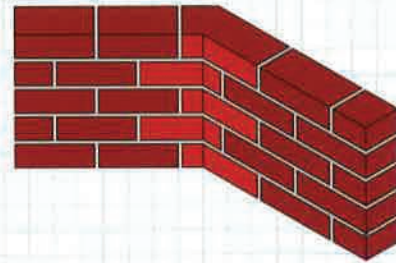

Arches

AR-1 Arch Header

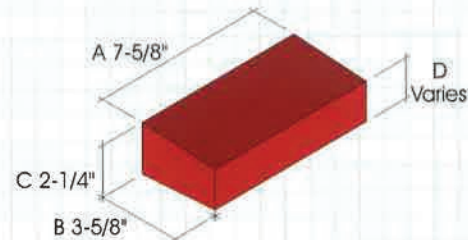
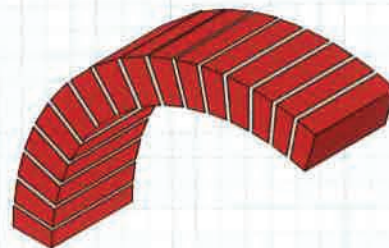

AR-2 Arch Stretcher

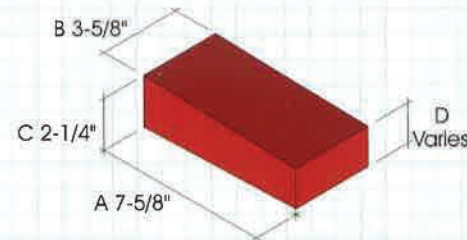
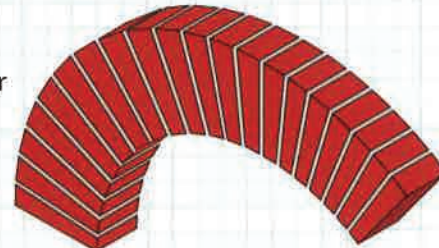

Arches

AR-3 Jack Arch
3 Course 2 Piece

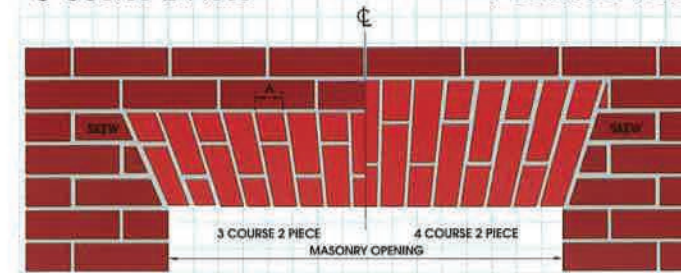

AR-4 Jack Arch
4 Course 2 Piece

AR-5 Jack Arch
3 Course 1 Piece

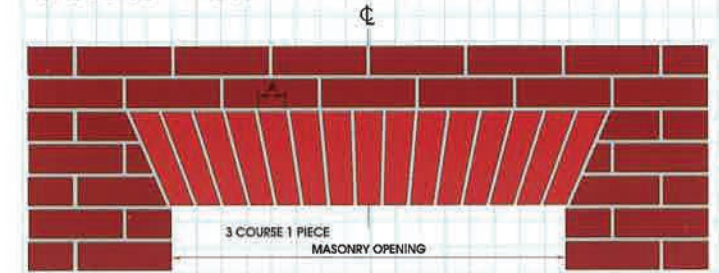

AR-6 Roman or Semi-Circular Arch
1 Piece

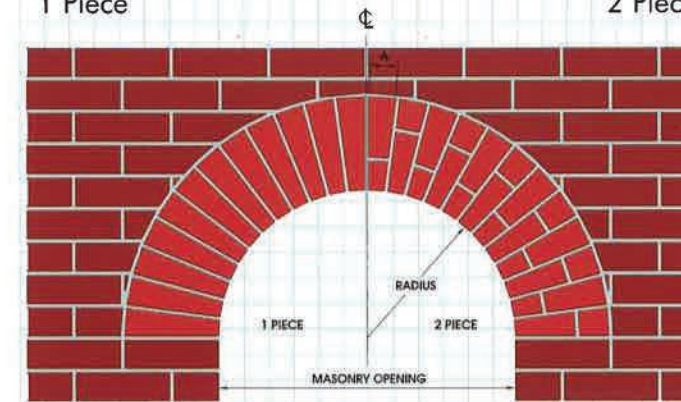

AR-7 Roman or Semi-Circular Arch
2 Piece

AR-8 Segmental Arch
1 Piece

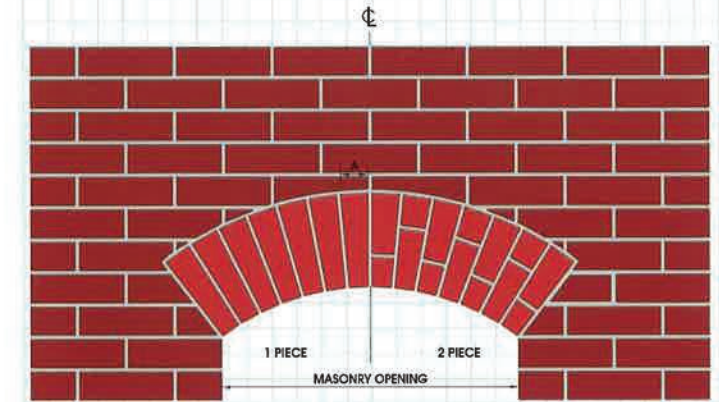

AR-9 Segmental Arch
2 Piece

AR-10 Circular Arch
1 Piece

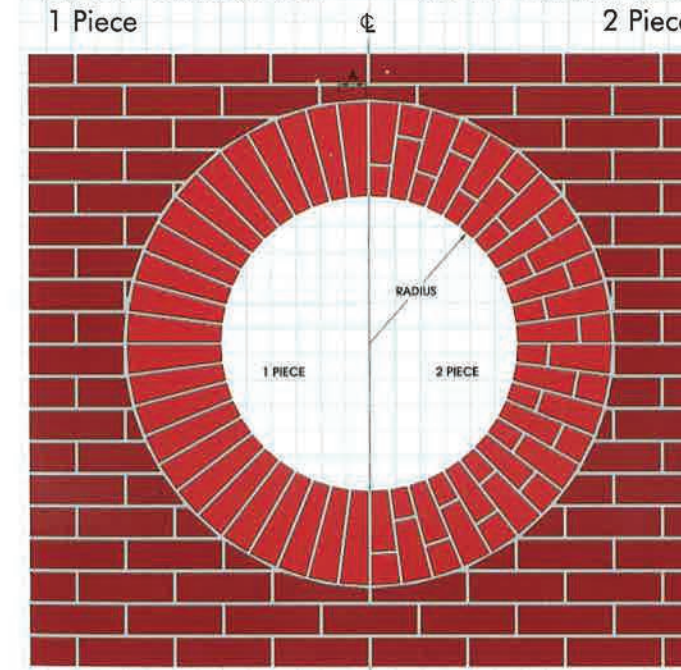

AR-11 Circular Arch
2 Piece

AR-12 Elliptical Arch
1 Piece

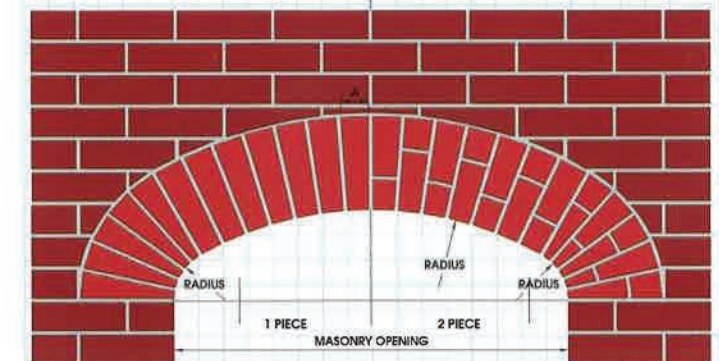

AR-13 Elliptical Arch
2 Piece

AR-14 Brick Key

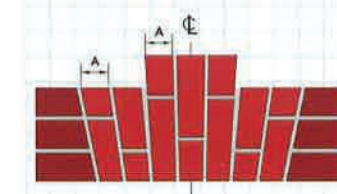

AR-15 Brick Key

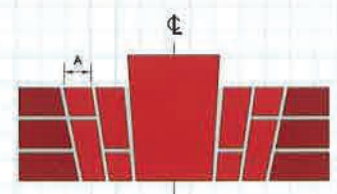

NOTE - ON ALL ARCHES "A" CANNOT EXCEED 2 1/4"

Bullnoses

BN-1
Single Bullnose

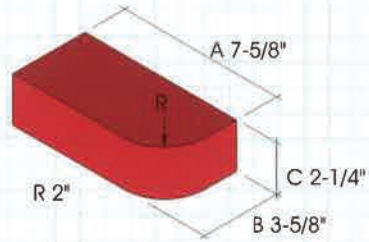
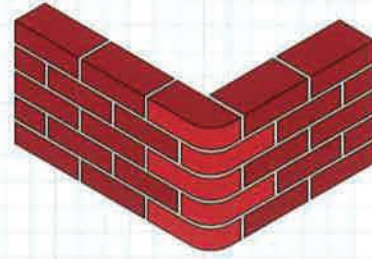

BN-2
Double Bullnose

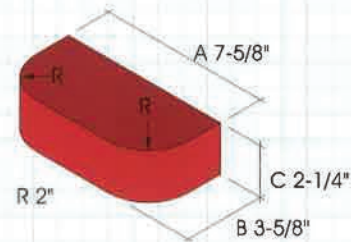
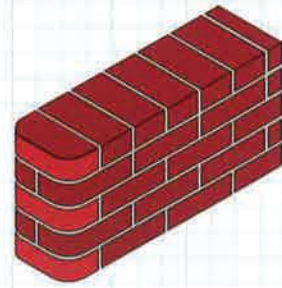

BN-3
Bullnose Stretcher

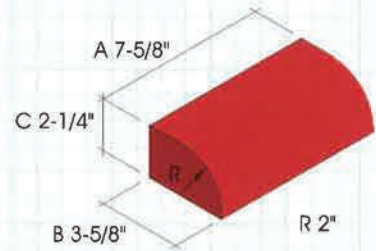
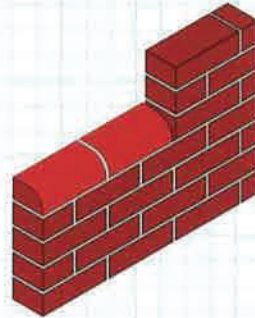

BN-4
Bullnose Corner

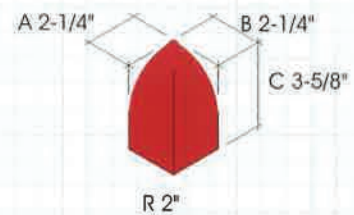
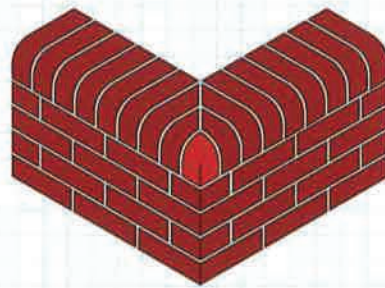

BN-5
Bullnose On End

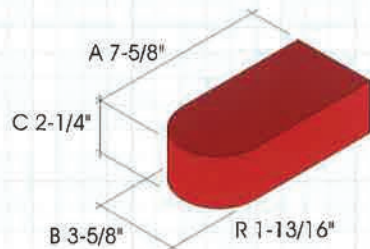
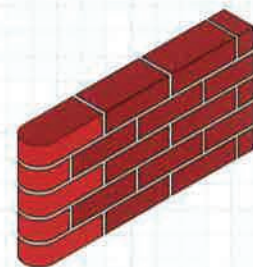

Coping Caps

CP-1
Coping Cap

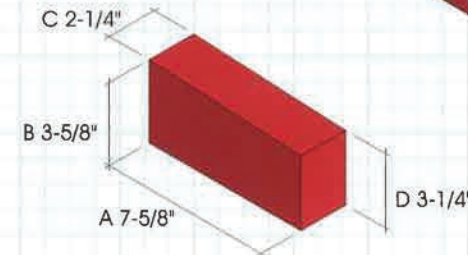
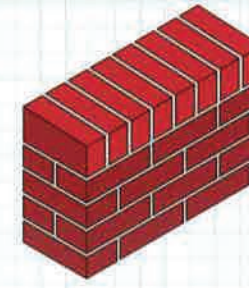

CP-2
Double Chamfer Coping Cap

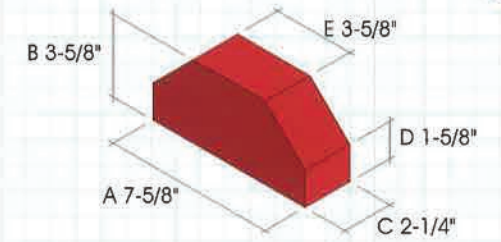
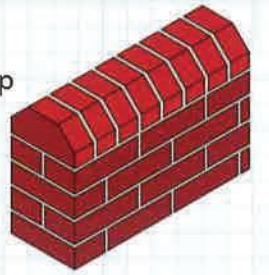

Coves

CV-1
Cove Header

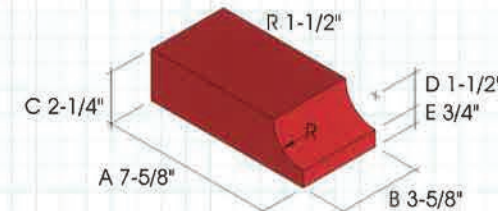
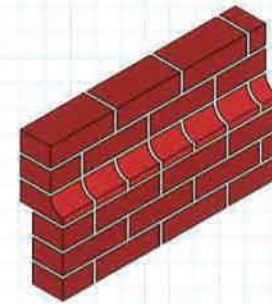

CV-2
Cove Header Corner

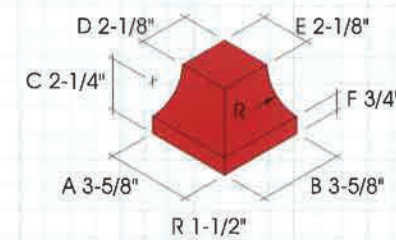
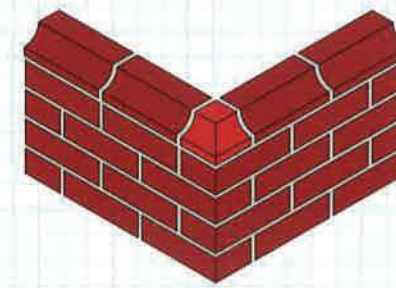

CV-3
Cove Stretcher

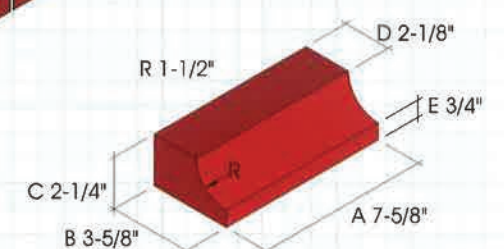
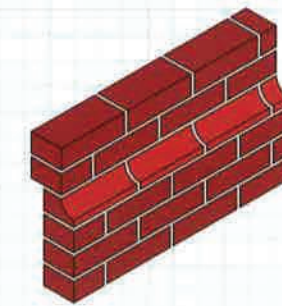

Pool Coping

PC-1
Pool Coping

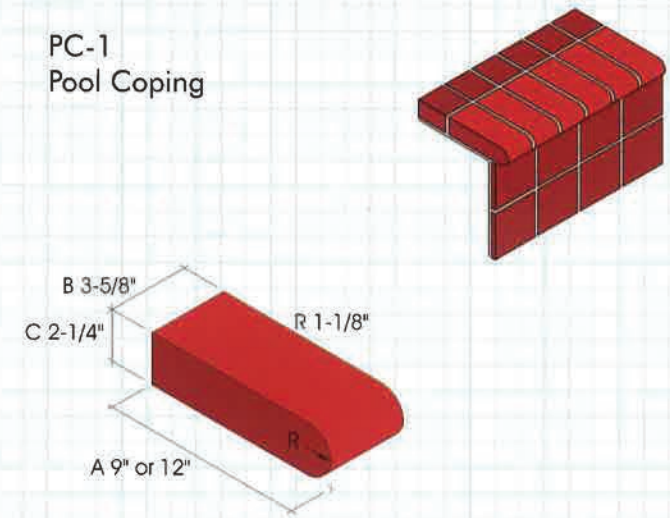

Shelf Angle

SA-1
Shelf Angle

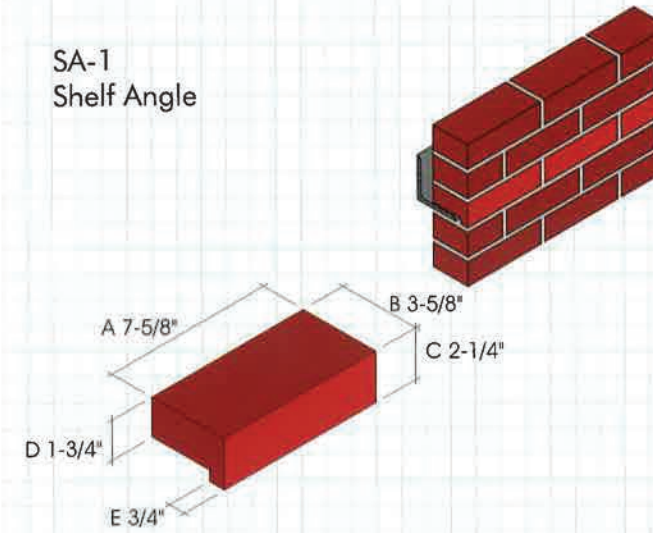

Sloped Sill

SL-1
Sloped Sill

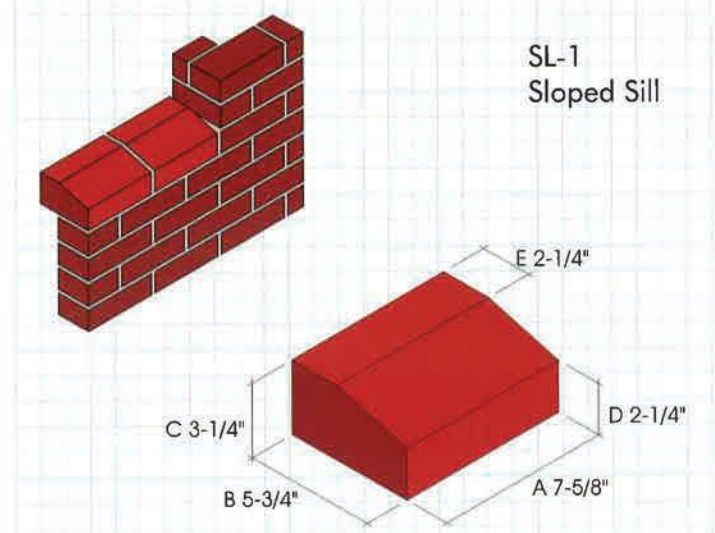

Radius

RD-1
Outside Radial
Stretcher

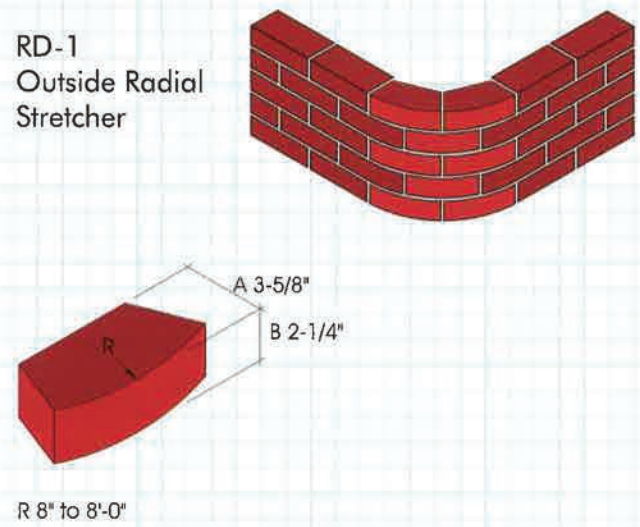

RD-2
Outside Radial
Starter

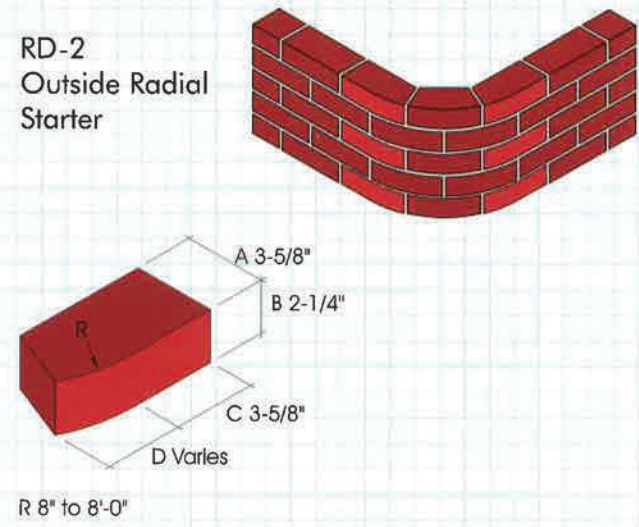

RD-3
Inside Radial
Stretcher

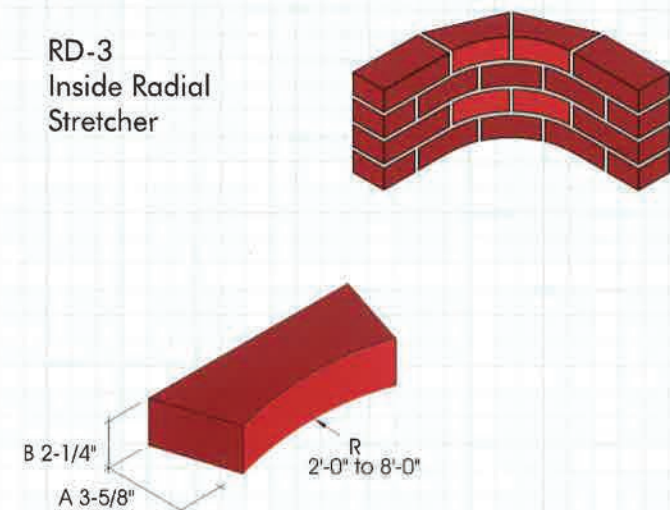

RD-4
Inside Radial
Starter

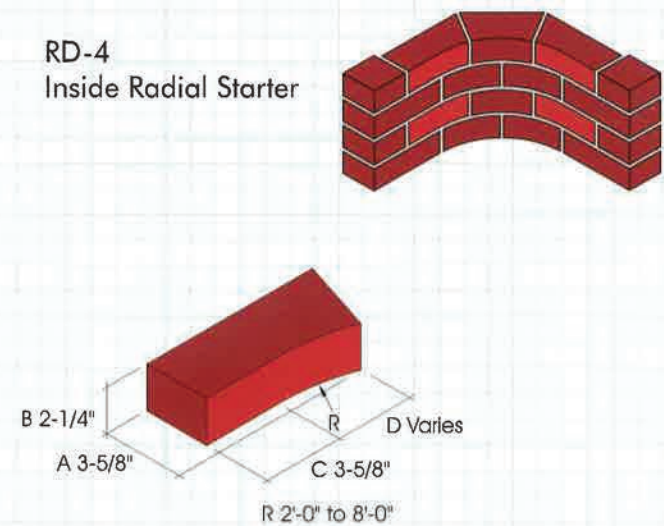

Soldiers

SD-1
Soldier Corner

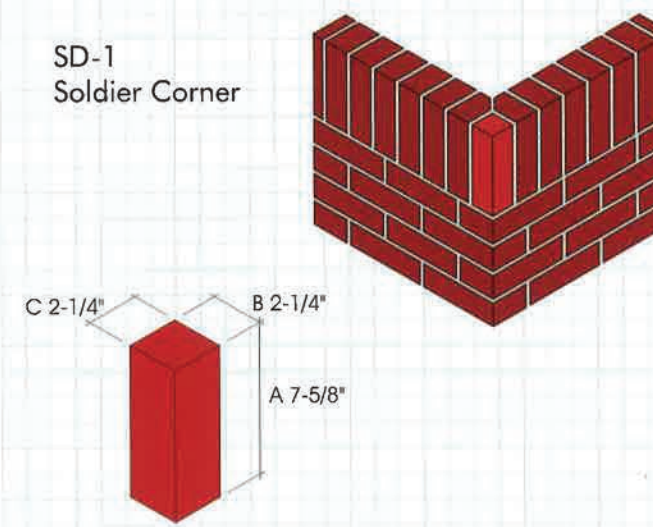

SD-2
External Soldier
Corner

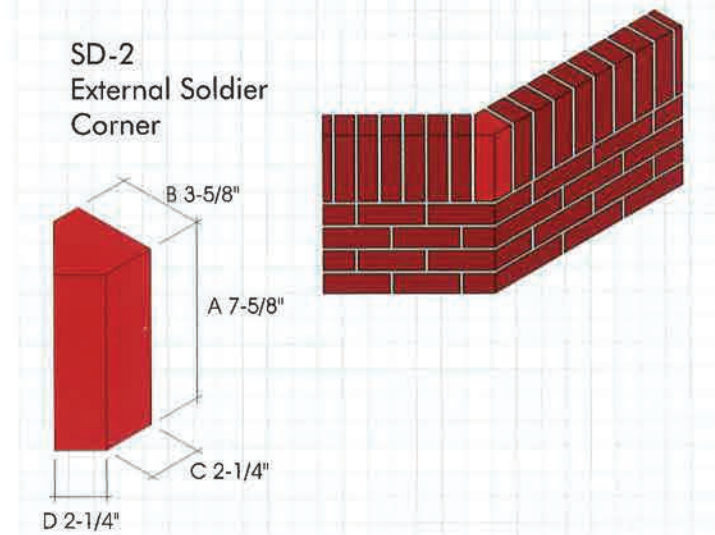

SD-3
Sloped Soldier

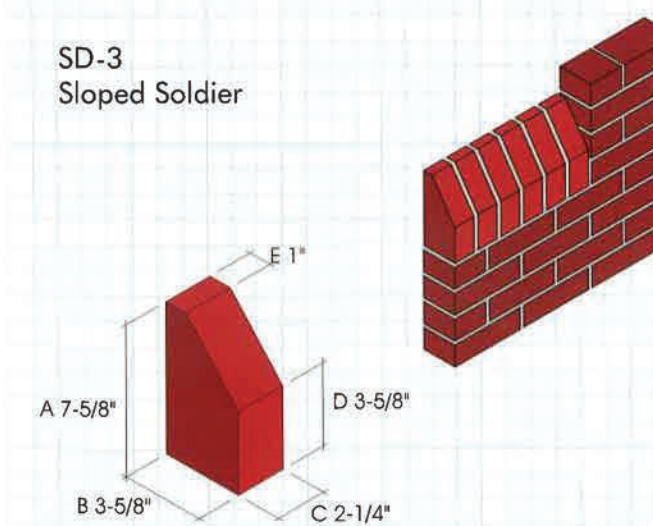

SD-4
Sloped Soldier
Corner

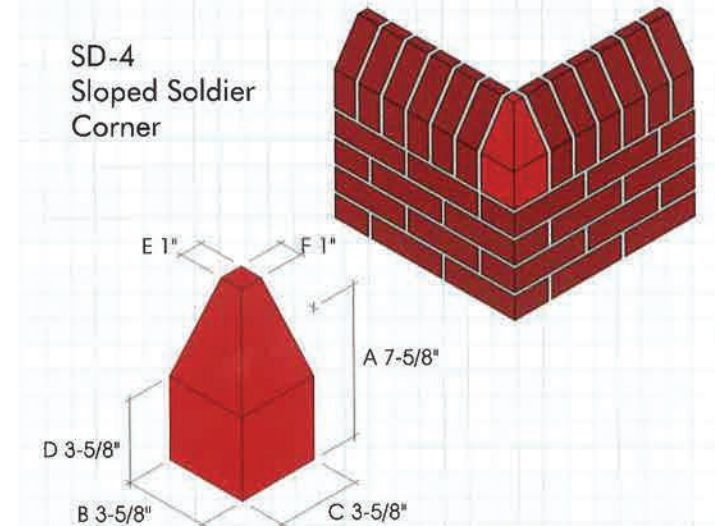

Watertables

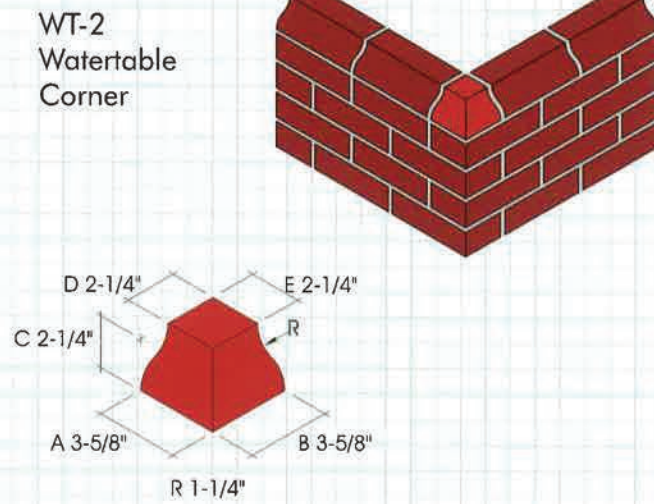
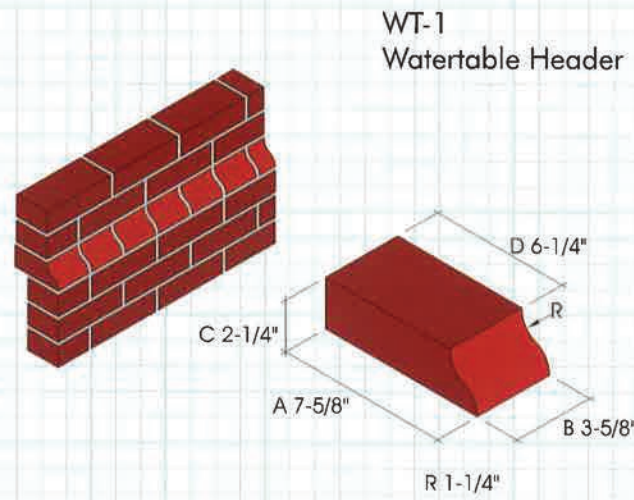

Watertables

