

From Wood to Great

Case Study in Metal

ENT Fort Worth, Clearfork



Acme Brick MAC Metal Architectural
Harrywood architectural metal panels

MAC
METAL ARCHITECTURAL

From Buckled and Bent
To Simply Beautiful

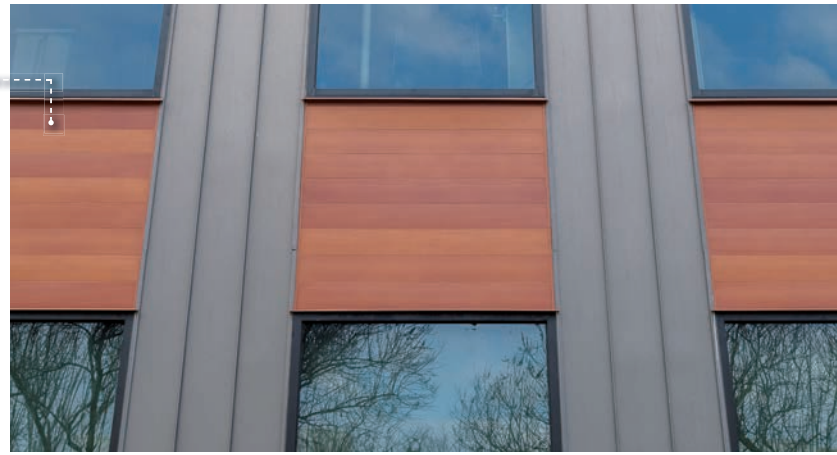

From Warp to Function:
Priced for Performance

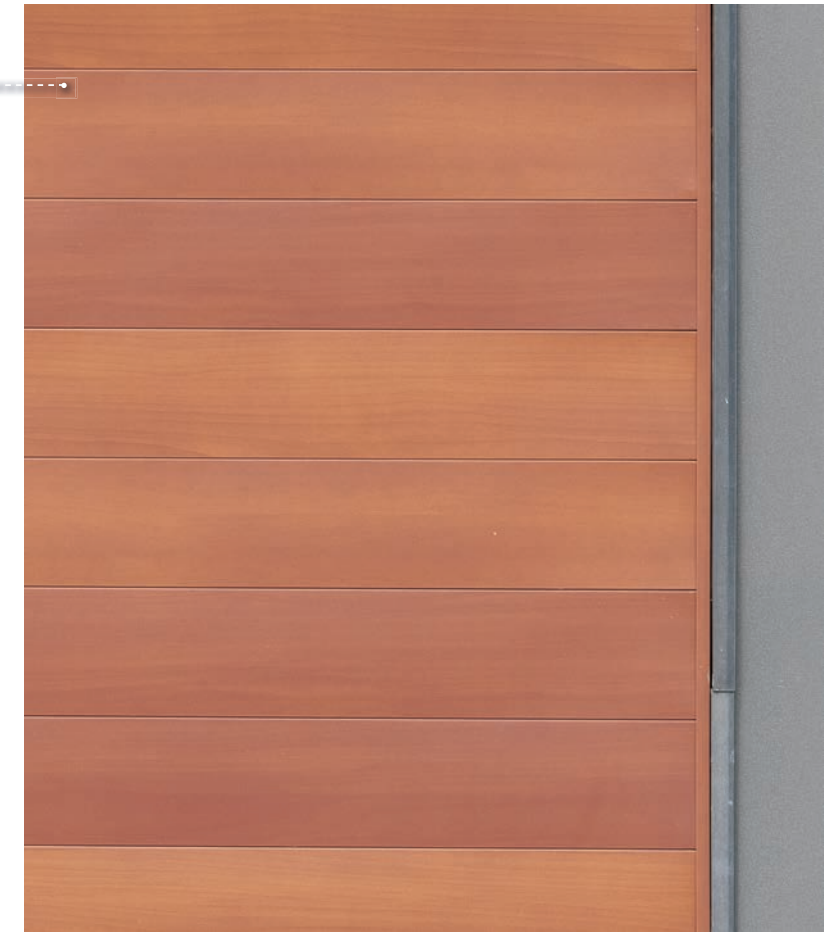

Not long after ENT Fort Worth at Clearfork was completed, its distinctive reclaimed Brazilian hardwood sections showed strain. Despite successful installations elsewhere across the country, the first six months of North Texas weather exacted a toll. Tight seams separated, and the wood discolored and warped, popping nails, and tilting and twisting out of its frame. That was before. Before, that is, the neighbors at Acme Brick suggested MAC Metal Architectural as a redeeming replacement solution.

MAC Metal offers the remarkable option of a wood appearance without the continual wood maintenance. Six different grain patterns and three different wood tones in each box ensure a variegated, natural look. Installers randomize the pattern, working with 12-foot long panels that have a 6 1/16" lap exposure. Fasteners are concealed, and the Harrywood profile can be installed horizontally, vertically or diagonally. Its 25-year fade warranty and 40-year product warranty rest on a PVDF paint system that includes a zinc primer, two paint primer coats, and three top coats on the exposed face.

Price is certainly a fair question. MAC Metal does have a higher material cost than wood, but then wood also requires trim, stain, paint/coatings, and labor to install. And with wood, the initial cost is only the beginning. A wood exterior requires regular maintenance, which gives MAC Metal a clear cost advantage over the span of a building's life cycle.

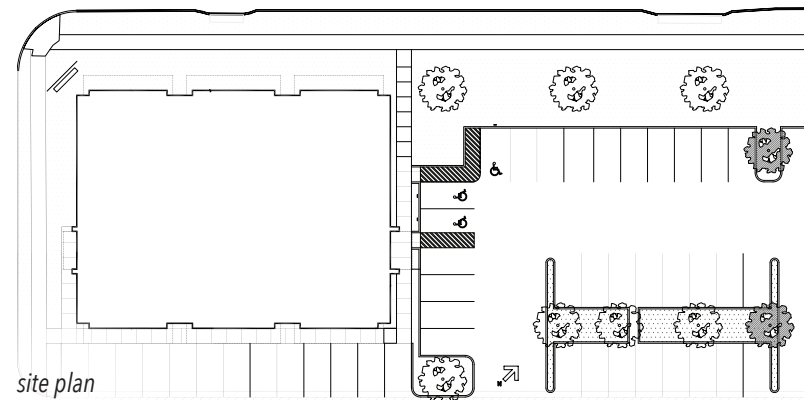

"It is frustrating, as an architect, to research a product, and to have it fail. We consulted with the original siding vendor on specifications, details, and installation. Nonetheless, we saw issues within the first year—board twist and warp. We tried simple modifications, consulting with the supplier, but it became evident that the original wood material could not withstand the Texas climate. We began researching a replacement, but strict rules on materiality in Clearfork meant limited solutions for a wood alternative. Having Acme Brick around the corner helped. Representatives watching the problems unfold reached out about MAC Metal, which compared well to fiber cement and other metal products, especially for long-term maintenance."

"The MAC panels maintained the warmth and varied appearance of the wood siding and kept the same sight lines. Replacement was simple. Once the siding was removed, and vapor barrier and sheathing inspected, the MAC panels were installed. The overall wall profile did not change. We were able to finish in six months, working in sections, in a continuous process. In the end, building materials must be beautiful and durable. We are pleased with the final product and can rest easy in the assurance of the MAC Metals system."

— Steven Halliday, AIA, LEED AP, 97w

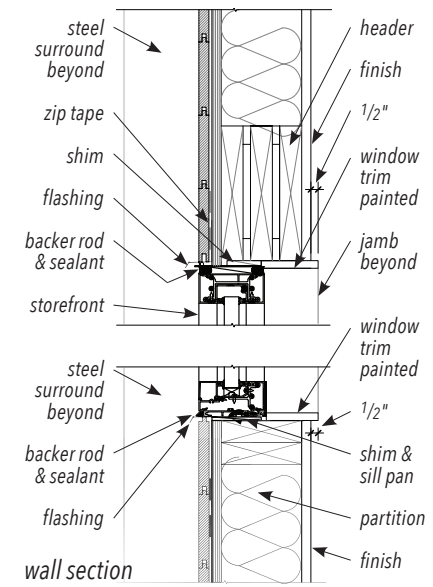

"MAC Metal was a little different to install than expected, because of angles and cuts to the panels, but I wish we had used it from the start. It looks fantastic. Even with an installer more used to framing, the process turned out well. We're convinced."

— Scott Price,
Fort Construction



panel trim

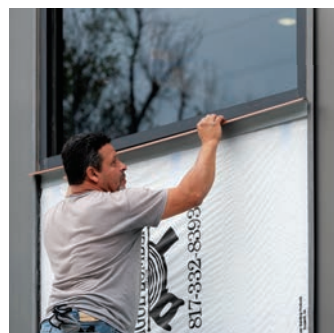

header install over vapor barrier

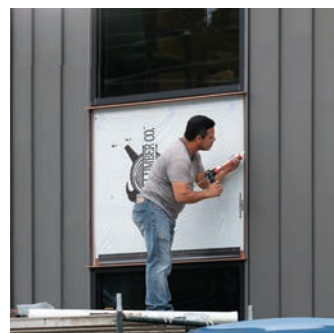

weatherproof sealant

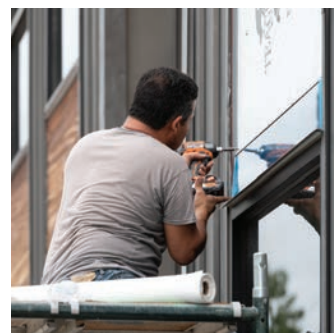

initial panel install

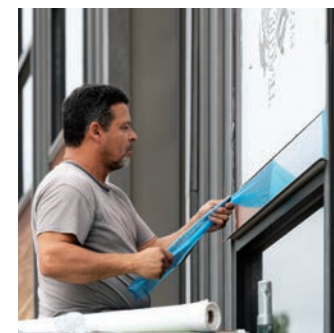

removal of protective film



site trim to randomize panels



easy handling of 12-foot panels



locking seam, flush finish panels

The Look of Wood Without the Maintenance

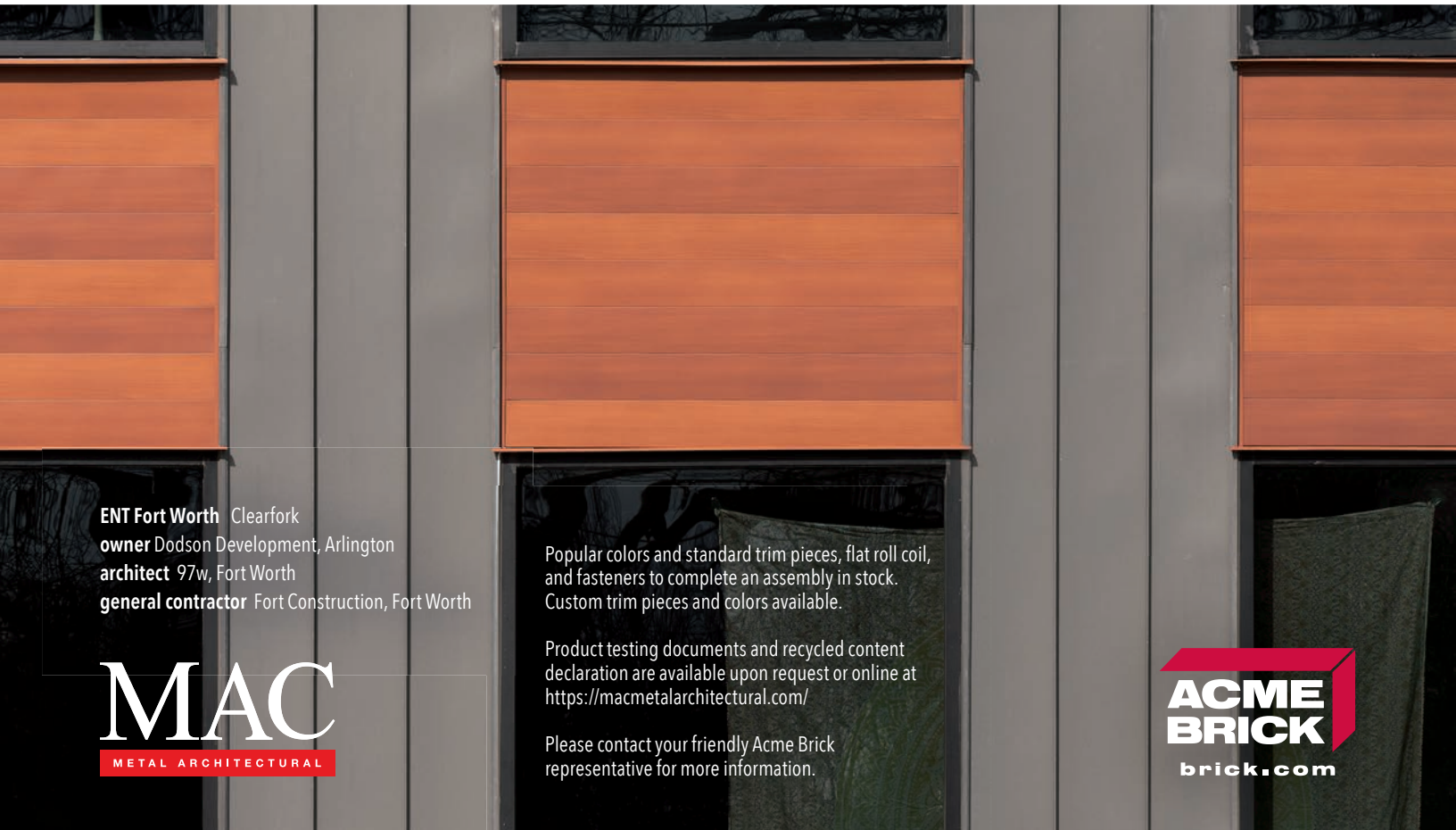

ENT Fort Worth Clearfork
owner Dodson Development, Arlington
architect 97w, Fort Worth
general contractor Fort Construction, Fort Worth

MAC
METAL ARCHITECTURAL

Popular colors and standard trim pieces, flat roll coil, and fasteners to complete an assembly in stock. Custom trim pieces and colors available.

Product testing documents and recycled content declaration are available upon request or online at <https://macmetalarchitectural.com/>

Please contact your friendly Acme Brick representative for more information.

**ACME
BRICK**
brick.com