

ISOKERN®

Fireplaces & Chimneys

Fireplaces, Accessories & Venting Solutions

**ACME
BRICK**

brick.com



earthcore®

ISOFLAMES

ISOPANEL

ISO'VEN

We Make Fire Better.

Custom Luxury Fireplaces

Extracted from Iceland's Mt. Hekla volcano, Isokern brand products have been made from the cleanest, purest pumice for over 80 years. Our masonry components cradle the raw power of fire in the safest, most energy-efficient material on earth. Totally customizable, Isokern allows architects and their clients to pursue their most inspired designs, while connecting with the natural beauty of fire.

A Name Built on
reliability for

30
years.

Since 1989, we have proudly provided exceptional products combined with unmatched customer service from our 8 solution centers and dedicated network of over 400 dealers.

Contents.

The Standard	1
Specifications.....	page 2
The Magnum	3
Specifications.....	page 5
The Magnum+	7
Specifications.....	page 9
The Maximus	11
Specifications.....	page 12
The Bvetto	13
Specifications.....	page 14
The Vent-Free	15
Specifications.....	page 16
DM54 Chimney	17
Specifications.....	page 18
EM40 Chimney	19
Specifications.....	page 20
Fireplace Enhancements	21
Firebrick.....	page 23
Isoflames.....	page 25
Premium Log Sets.....	page 26
Fire-Lite.....	page 27
Green Tech.....	page 28
Elemental Chimney Pots.....	page 29
EcoSteel & EcoSteel+	page 31
Outdoor Solutions	33
Isopanel.....	page 35
Kitchen Systems.....	page 37



Did You know?

Our pumice ships directly from the Mount Hekla Volcano in Iceland to our state-of-the-art automated manufacturing facility in Chesapeake, Virginia.

“Talent is a Flame,
Genius is a Fire.”

~ Bernard Williams

Insight into Our Technology

Our modular components cradle the raw power of fire in the safest, most energy-efficient material on earth. Due to the material's properties, the components are lightweight, while retaining UL 127 for Modular Masonry Fireplaces and UL 103HT for our Dual Modular Chimney System (respectively) listings. Isokern allows architects and their clients to pursue their most inspired designs, while connecting with the natural beauty of fire in a way that, until now, only nature could.

Our in-house designers and engineers work hand in hand with specification professionals for residential, commercial and institutional projects across North American.

ISOKERN® All Fuel Standard

Assembled Firebox and Smoke Dome Dimensions for 36, 42, 46



APPLICATIONS:

- Indoor
- Outdoor
- Wood
- Natural Gas
- LP (Liquid Propane)
- Custom Finish
- Multi-Sided Availability
- DM 54 Chimney | [page 17](#)
- Eco-Steel Chimney | [page 31](#)
- Fire-Lite Application | [page 27](#)

Make your ideal dream home a dream come true with Isokern's Standard Series.

As the first Isokern modular fireplace introduced in the United States, the modular construction of the Standard Series allows you to unleash your creative desires with a fireplace as unique as you are. Whether you choose wood burning, natural gas or liquid propane, the Standard Series sets the standard. In an outdoor application, this fireplace can be finished with any veneer including brick, stone, stucco, or tile.

Specifications

Please Note: When using the Isokern brick ledge it is required that the firebox/smoke dome assembly include the placement of a 4" by 4" by 3/8" minimum steel angle across the firebox opening. This item can be sourced locally.

Framing & Weight

Model	Minimum Framing	Weight
36	(46" w) x (65" h) x (26 3/4" d)	1205 lbs
42	(52" w) x (65" h) x (26 3/4" d)	1325 lbs
46	(56" w) x (65" h) x (26 3/4" d)	1450 lbs

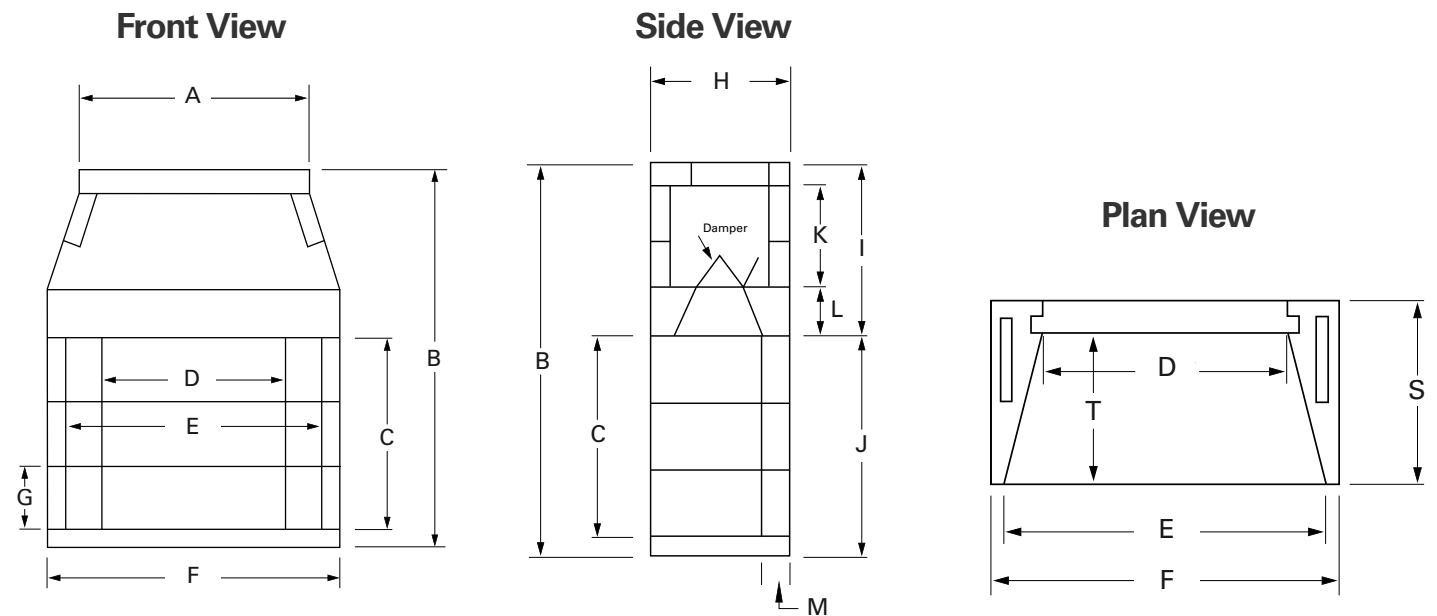

Front View	Model	A	B	C	D	E	F	G
	36	33"	63 1/4"	31 1/2"	27 1/4"	37 1/8"	43"	10 1/2"
	42	33"	63 1/4"	31 1/2"	33 1/4"	43 1/8"	49"	10 1/2"
	46	43"	63 1/4"	31 1/2"	37 1/4"	47 1/8"	53"	10 1/2"

Side View	Model	B	C	H	I	J	K	L	M
	36	63 1/4"	31 1/2"	25 1/4"	28 3/4"	34 1/2"	16"	8"	5"
	42	63 1/4"	31 1/2"	25 1/4"	28 3/4"	34 1/2"	16"	8"	5"
	46	63 1/4"	31 1/2"	25 1/4"	28 3/4"	34 1/2"	16"	8"	5"

Plan View	Model	D	E	F	S	T
	36	27 1/4"	37 1/8"	43"	25 1/4"	20 1/4"
	42	33 1/4"	43 1/8"	49"	25 1/4"	20 1/4"
	46	37 1/4"	47 1/8"	53"	25 1/4"	20 1/4"

ISOKERN® All Fuel Magnum

Assembled Firebox and
Smoke Dome Dimensions
for 28, 36, 42, 48, 60 & 72



APPLICATIONS:

- Indoor
- Outdoor
- Wood
- Natural Gas
- LP (Liquid Propane)
- Custom Finish
- Multi-Sided Availability
- DM 54 Chimney | [page 17](#)
- Eco-Steel Chimney | [page 31](#)
- Fire-Lite Application | [page 27](#)

Fan the flames of innovation and take your fireplace to new heights with Isokern's Magnum Series.

The Magnum Series Fireplace offers wood or gas burning solutions with the largest openings available in the market, models include 36, 42, 48, 60 & 72. Utilizing Isokern's proprietary straight-back interior design coupled with an innovative contoured shelf, the modular Magnum Series provides unequalled efficiency, performance and custom fireplace design flexibility.

Specifications - 28, 36, 42, 48

Please Note: When using the Isokern brick ledge, it is required that the firebox/smoke dome assembly include the placement of a 4" x 4" x 3/8" minimum steel angle across the firebox opening. This item can be sourced locally.

Framing & Weight		
Model	Minimum Framing	Weight
28	(38 1/2"w) x (61 1/2"h) x (29 1/2"d)	1040 lbs
36	(46"w) x (71"h) x (29 1/2"d)	1305 lbs
42	(52"w) x (71"h) x (29 1/2"d)	1425 lbs
48	(56"w) x (71"h) x (29 1/2"d)	1600 lbs

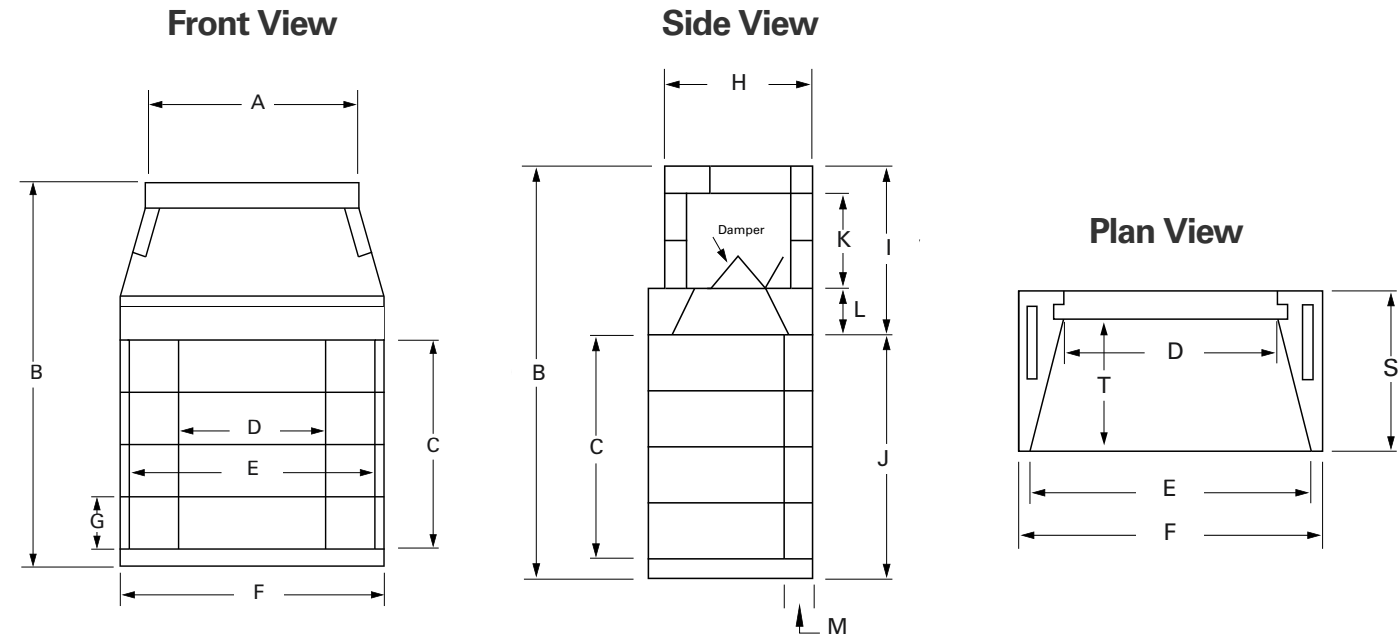

Front View	Model	A	B	C	D	E	F	G
	28	22 1/4"	60 1/4"	28 1/2"	19 3/4"	31"	35 1/2"	9 1/2"
	36	33"	69 3/4"	38"	27 1/4"	38 3/4"	43"	9 1/2"
	42	33"	69 3/4"	38"	33 1/4"	44 1/2"	49"	9 1/2"
	48	43"	69 3/4"	38"	37 1/4"	48 1/2"	53"	9 1/2"

Side View	Model	B	C	H	I	J	K	L	M
	28	60 1/4"	28 1/2"	25 1/4"	28 3/4"	31 1/2"	16"	8"	5"
	36	69 3/4"	38"	25 1/4"	28 3/4"	41"	16"	8"	5"
	42	69 3/4"	38"	25 1/4"	28 3/4"	41"	16"	8"	5"
	48	69 3/4"	38"	25 1/4"	28 3/4"	41"	16"	8"	5"

Plan View	Model	D	E	F	S	T
	28	19 3/4"	31"	35 1/2"	28"	23"
	36	27 1/4"	38 3/4"	43"	28"	23"
	42	33 1/4"	44 1/2"	49"	28"	23"
	48	37 1/4"	48 1/2"	53"	28"	23"

Specifications 60 & 72

Please Note: It is required that the firebox/smoke dome assembly include the placement of a 4" x 6" x 3/8" minimum steel angle across the firebox opening. This item can be sourced locally. The manufacturer requires for the 60 & 72 model fireboxes be lined with a minimum 1-1/4" (2-1/2" Fire-lite application) thick firebrick for the floor and backwall and four inch (4") firebrick on the sidewalls.

Framing & Weight		
Model	Minimum Framing	Weight
60	(76 1/2"w) x (87 1/4"h) x (29 1/2"d)	2652 lbs
72	(88 7/8"w) x (87 1/4"h) x (29 1/2"d)	2952 lbs

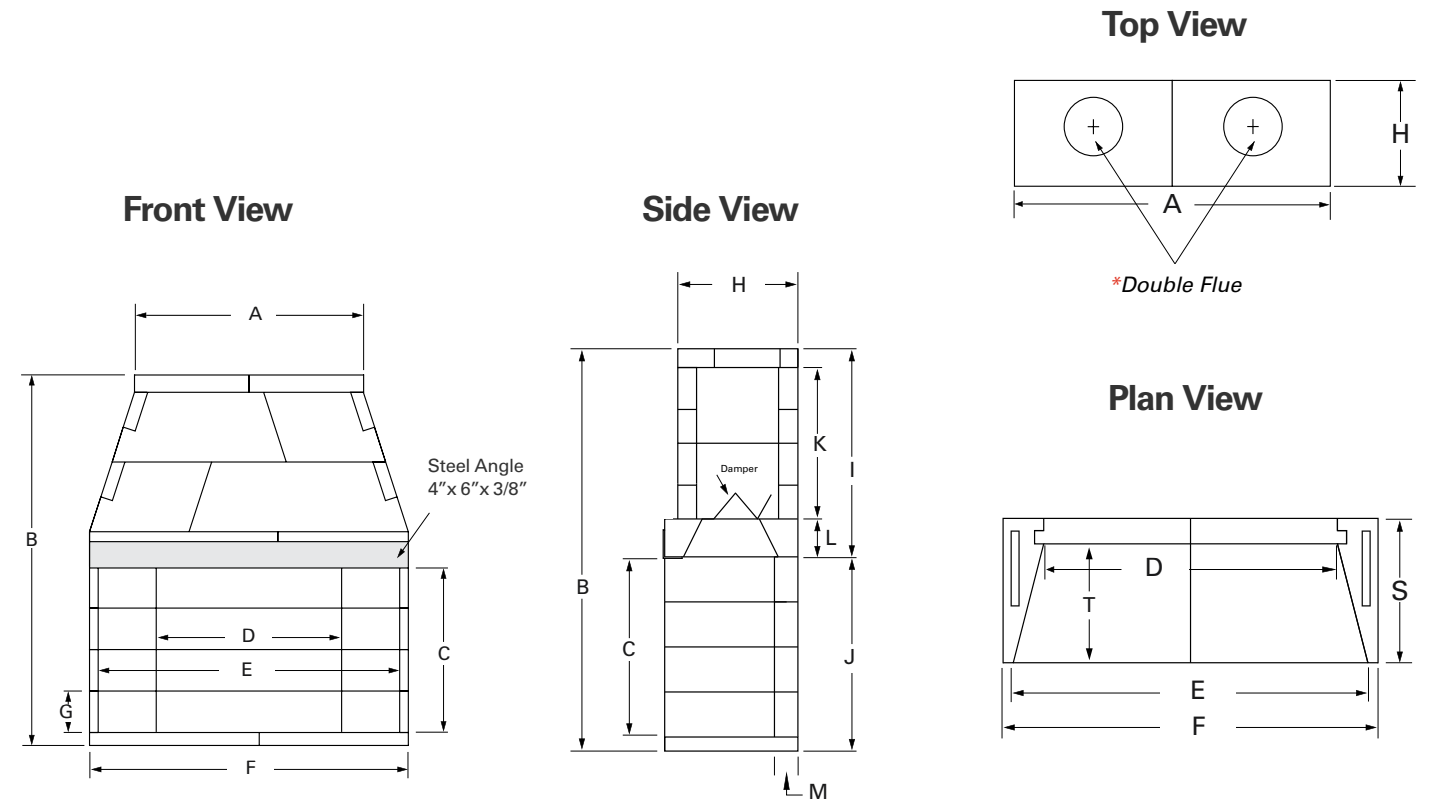

Front View	Model	A	B	C	D	E	F	G
	60	53 1/2"	85 3/4"	38"	57 1/4"	69"	73 1/2"	9 1/2"
	72	66"	85 3/4"	38"	69 3/4"	81 1/4"	85 1/2"	9 1/2"

Side View	Model	B	C	H	I	J	K	L	M
	60	85 3/4"	38"	25 1/4"	44 3/4"	41"	32"	8"	5"
	72	85 3/4"	38"	25 1/4"	44 3/4"	41"	32"	8"	5"

Plan View	Model	D	E	F	S	T
	60	57 1/4"	69"	73 1/2"	28"	23"
	72	69 3/4"	81 1/4"	85 1/2"	28"	23"



ISOKERN[®] All Fuel
Magnum[±]

When you're designing a space that's larger than life, you need a fireplace to match it! **NEW** from Isokern is our ground-breaking **Magnum[±] Fireplace**.

Boasting widths up to 10 feet and finished opening heights of 44", this stately fireplace is the largest UL listed fireplace on the market. Earthcore is always looking to expand the boundaries of fire, and with the Magnum[±] fire has no boundaries.

** Angle iron support not pictured but required.*

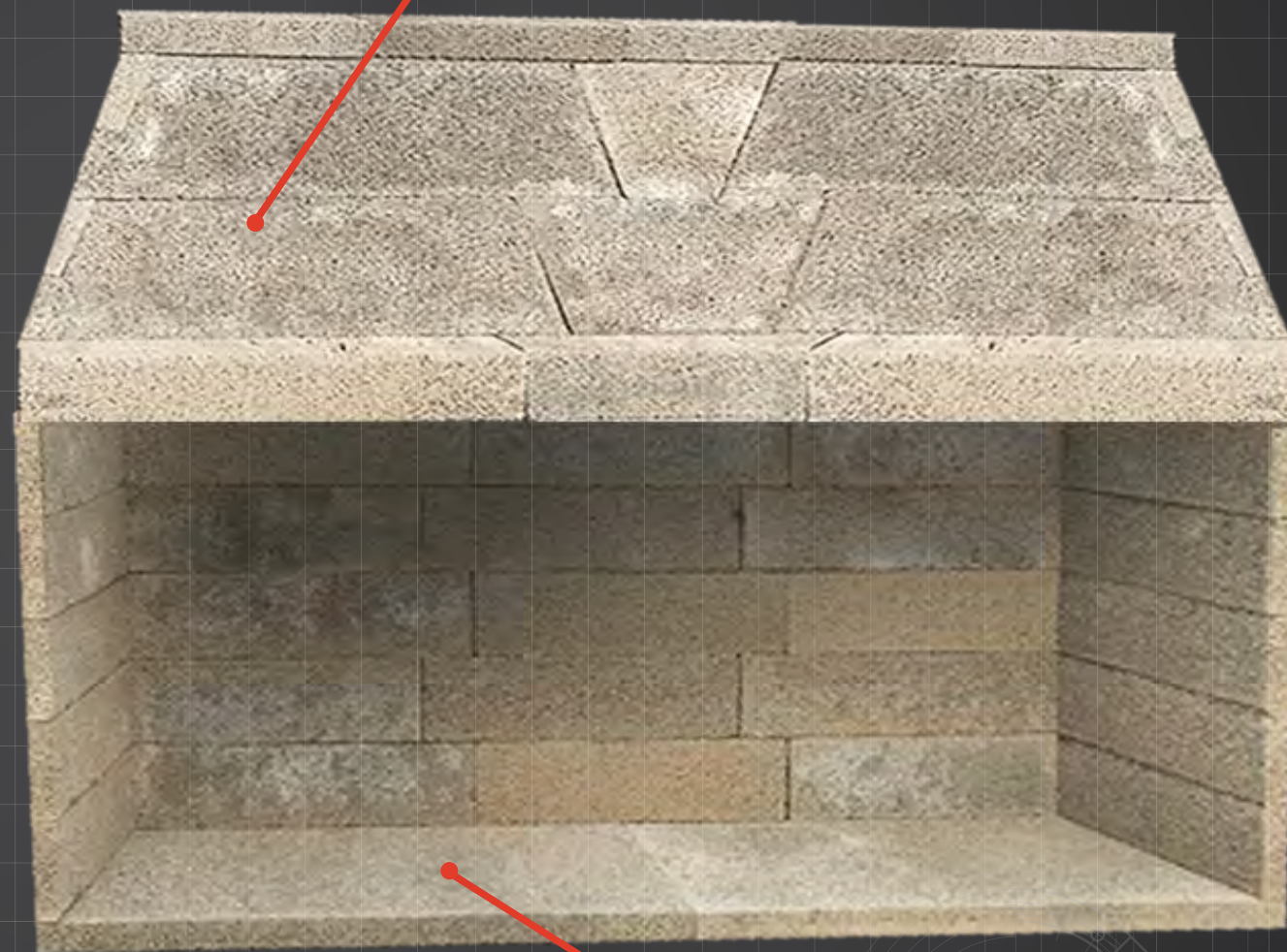

Solid Fuel or Gas
The largest UL listed wood burning fireplace on the market.

Open Sizes Customized to Your Project
Opening widths of up to 10 feet.

Specifications - 84, 96, 108, 120

Please Note: It is required that the firebox/smoke dome assembly include the placement of a 6" x 6" x 3/4" minimum steel angle across the firebox opening. This item can be sourced locally. Eco-Steel or Eco-Steel+ is the required flue system for this fireplace. The 84 Magnum+ requires 3 flue outlets. Models 96-120 require 4 flue outlets*.

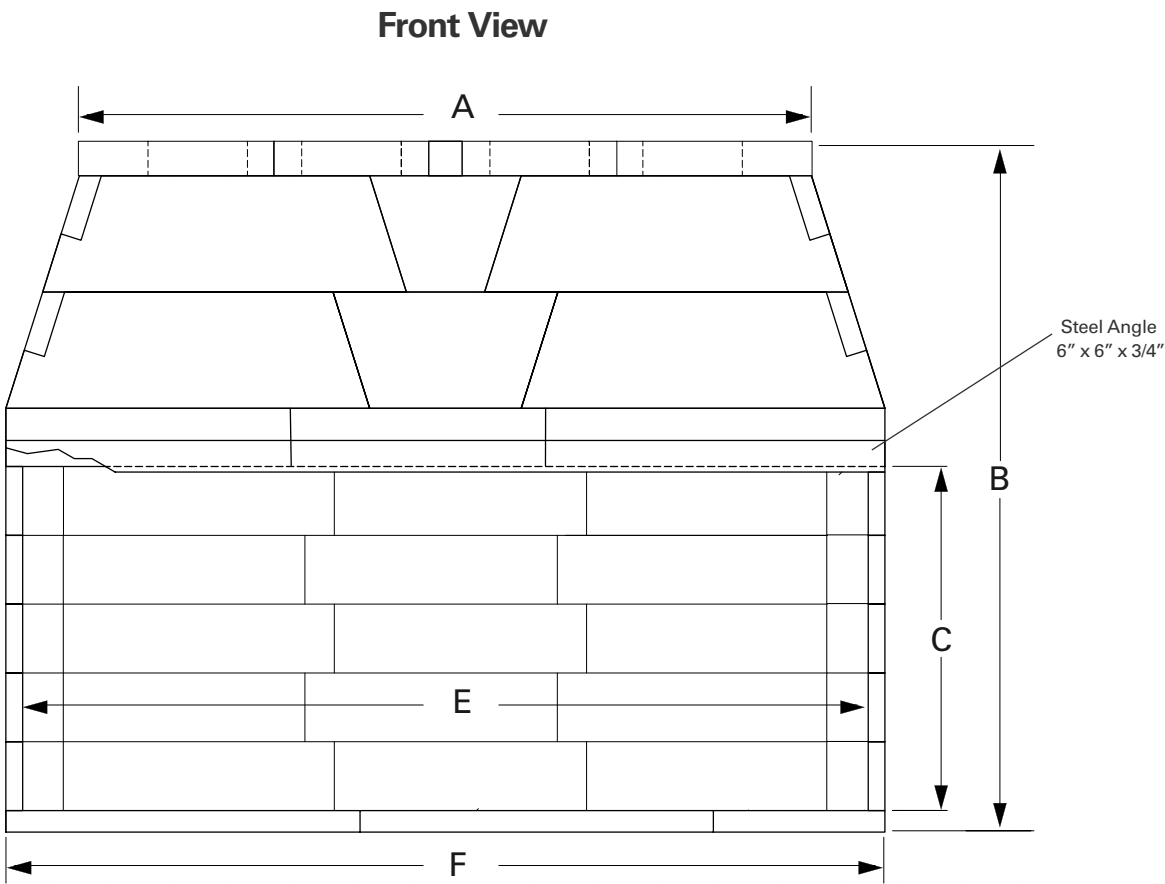

Front View	Model	A	B	C	E	F
	84	74 11/16"	94 1/2"	47 1/16"	91 1/16"	95 11/16"
	96	88 1/16"	93 11/16"	47 1/16"	103 5/8"	108 3/16"
	108	100 3/16"	94 1/2"	47 1/16"	115 5/8"	120 3/16"
	120	111 5/8"	94 1/2"	47 1/16"	127 1/8"	131 3/4"

Framing & Weight		
Model	Minimum Framing	Weight
84	(99"w) x (97"h) x (29 1/2"d)	3198 lbs
96	(111 1/2"w) x (97"h) x (29 1/2"d)	3515 lbs
108	(123 1/2"w) x (97"h) x (29 1/2"d)	3979 lbs
120	(135"w) x (97"h) x (29 1/2"d)	4265 lbs

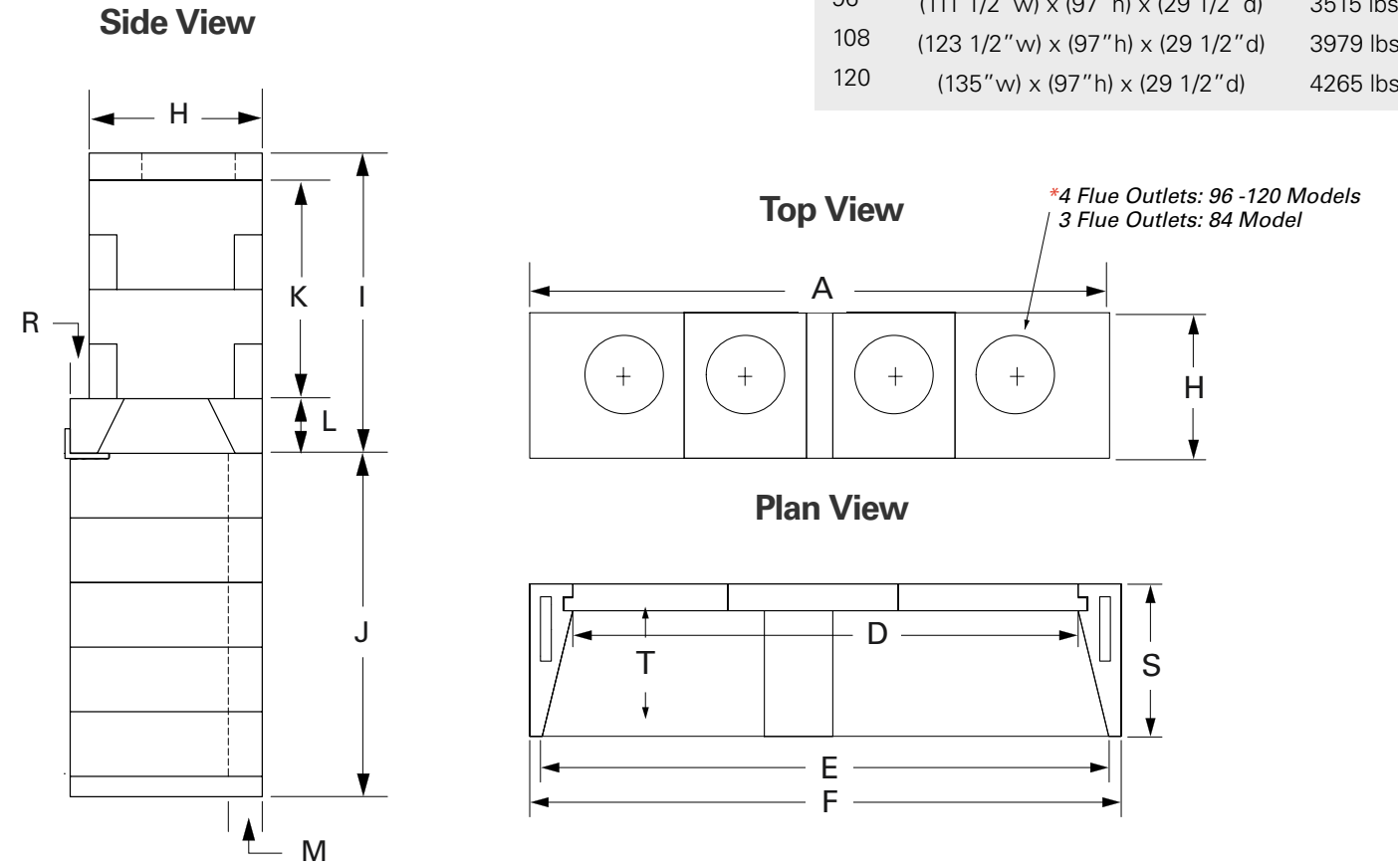

Plan View	Model	D	E	F	S	T
	84	83 1/16"	91 1/16"	95 11/16"	28"	23"
	96	95 5/8"	103 5/8"	108 3/16"	28"	23"
	108	107 5/8"	115 5/8"	120 3/16"	28"	23"
	120	119 1/8"	127 1/8"	131 3/4"	28"	23"

Side View	Model	H	I	J	K	L	M	R
	84	25 1/4"	44 3/4"	50 1/2"	32"	8"	5"	2 3/4"
	96	25 1/4"	44 3/4"	50 1/2"	32"	8"	5"	2 3/4"
	108	25 1/4"	44 3/4"	50 1/2"	32"	8"	5"	2 3/4"
	120	25 1/4"	44 3/4"	50 1/2"	32"	8"	5"	2 3/4"

ISOKERN[®] Direct Vent Maximus

Assembled Firebox and
Smoke Dome Dimensions
for 46 & 48



APPLICATIONS:

- Indoor
- Natural Gas
- LP (Liquid Propane)
- Custom Finish
- Direct Vent Chimney | [page 17](#)
- Combustible Floor Installation

Put the awe-inspiring power of fire on full display with Isokern's Maximus Series.

The Isokern MAXIMUS Series is the first ever masonry direct vent fireplace. Offering an expansive ceramic glass opening with Invisi-Barrier and Triple Stadium Burner for exceptional appearance and flame presentation. With an array of options, the MAXIMUS provides endless possibilities for making your space warm and inviting.

Specifications

Please Note: Additional clearance of 12" may be required from side wall where the air intake is located. The air intake is listed at zero (0") clearance to combustible framing and can be routed through framing if required.

Framing & Weight

Model	Minimum Framing	Weight
46	(56" w) x (65" h) x (26 3/4" d)	1450 lbs
48	(56" w) x (71" h) x (29 1/2" d)	1600 lbs

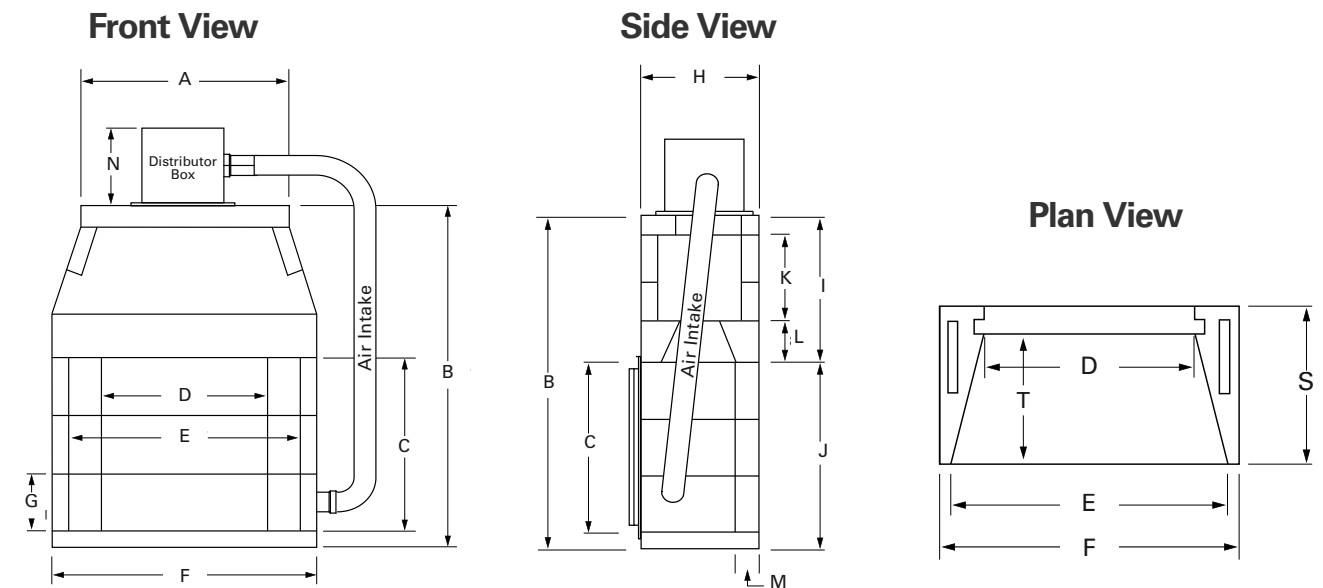

Front View	Model	A	B	C	D	E	F	G	N
	46	43"	63 1/4"	31 1/2"	37 1/4"	47 1/8"	53"	10 1/2"	11 3/4"
	48	43"	69 3/4"	38"	37 1/4"	48 1/2"	53"	9 1/2"	11 3/4"

Side View	Model	B	C	H	I	J	K	L	M
	46	63 1/4"	31 1/2"	25 1/4"	28 3/4"	34 1/2"	16"	8"	5"
	48	69 3/4"	38"	28"	28 3/4"	41"	16"	8"	5"

Plan View	Model	D	E	F	S	T
	46	37 1/4"	47 1/8"	53"	25 1/4"	20 1/4"
	48	37 1/4"	48 1/2"	53"	28"	23"

ISOKERN® Gas Only Bvetto

Assembled Firebox and
Smoke Dome Dimensions
for 36 & 46



Opening heights sure to make a true statement in any living space with Isokern's Bvetto Series.

As the first and only field assembled gas appliance fireplace, the Isokern Bvetto Series offers the largest available opening heights in the industry of 52". With our proprietary quick fire ignition system, the Isokern Bvetto comes complete with our exclusive Isoflames Stadium Burner and Remote Electronic Ignition.

APPLICATIONS:

- Indoor
- Natural Gas
- LP (Liquid Propane)
- B-Vent Chimney
- Combustible Floor Installation
- Custom Finish

Specifications

Please Note: Different height options are available for the Bvetto fireplace. One additional backwall and two additional sidewalls can be added to obtain an opening of 42" tall before brick is installed. Two additional backwalls and four additional sidewalls can be added to obtain an opening of 52½" tall before brick is installed. Only Isoflames log sets can be used in this unit.

Framing & Weight

Model	Minimum Framing	Weight
36	(46"w) x (65"h) x (26 3/4"d)	1500 lbs
46	(52"w) x (65"h) x (26 3/4"d)	1700 lbs

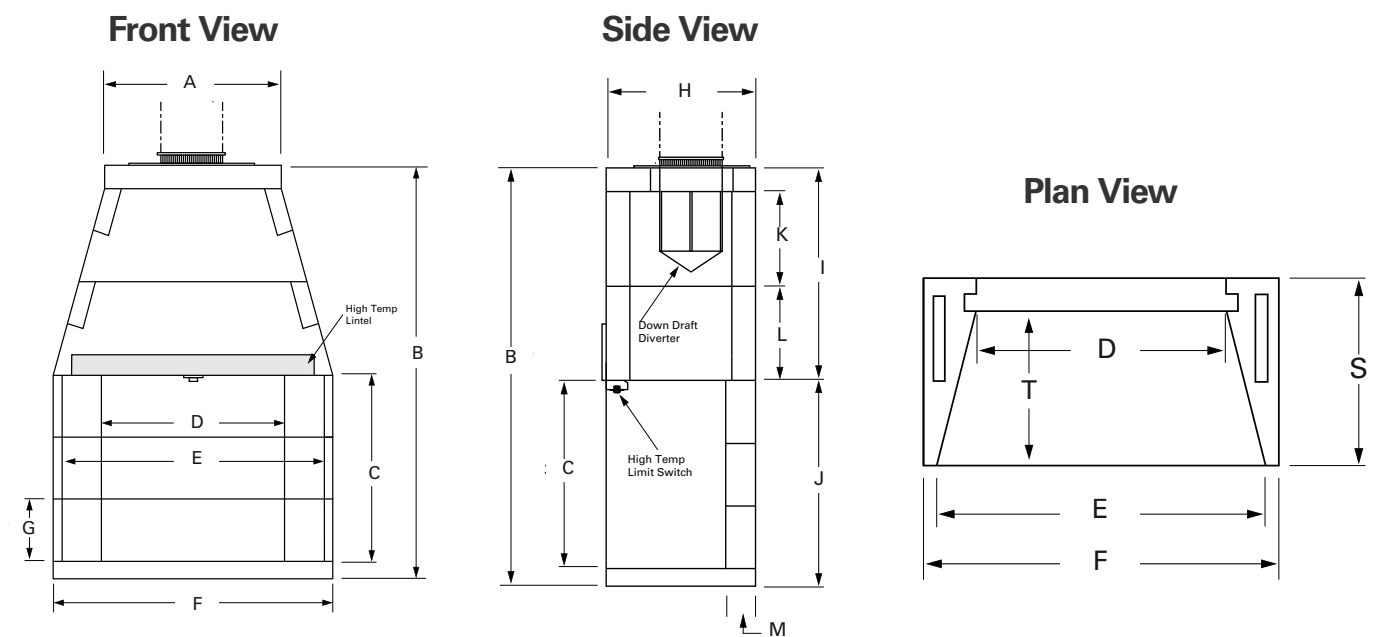

Front View	Model	A	B	C	D	E	F	G
	36	22 1/2"	71 1/4"	31 1/2"	27 1/4"	36 1/8"	43"	10 1/2"
	46	33 1/2"	71 1/4"	31 1/2"	37 1/4"	48 1/8"	53"	10 1/2"

Side View	Model	B	C	H	I	J	K	L	M
	36	71 1/4"	31 1/2"	25 1/4"	36 3/4"	34 1/2"	16"	16"	5"
	46	71 1/4"	31 1/2"	25 1/4"	36 3/4"	34 1/2"	16"	16"	5"

Plan View	Model	D	E	F	S	T
	46	27 1/4"	36 1/8"	43"	25 1/4"	20 1/4"
	48	37 1/4"	48 1/2"	53"	25 1/4"	20 1/4"

ISOKERN® Gas Only Vent-Free

Assembled Firebox and
Smoke Dome Dimensions
for 36, 42 & 46



APPLICATIONS:

- Indoor
- Outdoor
- Natural Gas
- LP (Liquid Propane)
- Unvented
- Multi-Sided Availability
- Combustible Floor Installation
- Custom Finish

A gas fireplace blends seamlessly into your home's footprint, with Isokern's Vent-Free Series.

The Vent-Free series offers a variety of opening heights and is fully customizable to fit in with any design plan. With its large finished openings and see-thru availability, the Vent-Free Series is a perfect heating solution for any multi-family home, new home, remodeling project or outdoor concept.

Specifications

Please Note: Zero clearance to combustible material.

Framing & Weight

Model	Minimum Framing	Weight
36	(46" w) x (65" h) x (26 3/4" d)	1205 lbs
42	(52" w) x (65" h) x (26 3/4" d)	1325 lbs
46	(56" w) x (65" h) x (26 3/4" d)	1450 lbs

Front View

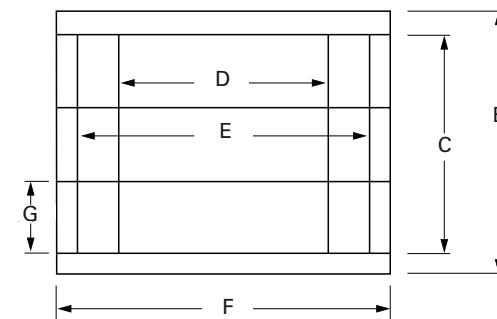

Side View

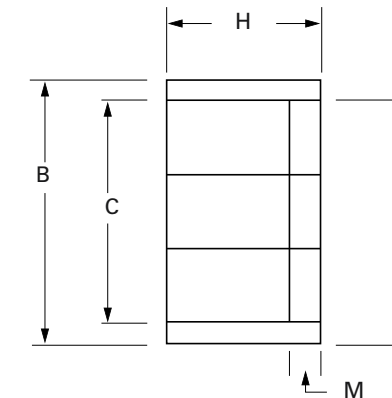

Plan View

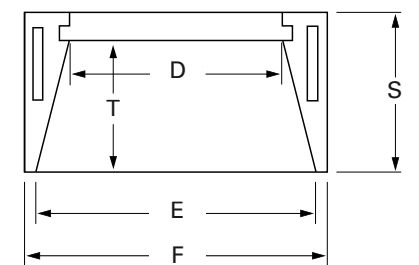

Front View	Model	B	C	D	E	F	G
	36	63 1/4"	31 1/2"	27 1/4"	37 1/8"	43"	10 1/2"
	42	63 1/4"	31 1/2"	33 1/4"	43 1/8"	49"	10 1/2"
	46	63 1/4"	31 1/2"	37 1/4"	47 1/8"	53"	10 1/2"

Side View	Model	B	C	H	I	J	K	L	M
	36	63 1/4"	31 1/2"	25 1/4"	28 3/4"	34 1/2"	16"	8"	5"
	42	63 1/4"	31 1/2"	25 1/4"	28 3/4"	34 1/2"	16"	8"	5"
	46	63 1/4"	31 1/2"	25 1/4"	28 3/4"	34 1/2"	16"	8"	5"

Plan View	Model	D	E	F	S	T
	36	27 1/4"	37 1/8"	43"	25 1/4"	20 1/4"
	42	33 1/4"	43 1/8"	49"	25 1/4"	20 1/4"
	46	37 1/4"	47 1/8"	53"	25 1/4"	20 1/4"

ISOKERN[®] Chimney Dual Module

DM54 Chimney System
for Isokern Standard &
Magnum Fireplaces



Isokern Chimney Systems have vented over 155 million meters of chimney in North America.

The DM54 Chimney System is zero clearance system made with our Icelandic Pumice that is a natural insulator. This unique property is what separates our pumice from all other chimney materials. The insulating properties of Pumice allow the flue gases in the chimney to quickly reach their optimum temperature, enabling the heating appliance to perform efficiently. It also keeps the chimney warmer longer as the heat output of the fireplace decreases. This not only aids performance, but reduces the likelihood of condensation and soot build-up.

Our Component based system is made up of inner and outer blocks that are laid with staggering joints for safety and stability. The double layer of pumice blocks, separated by an air gap, maximizes the chimney insulation. This system is the only masonry chimney system tested and listed to UL 103HT (2100° High Temperature) standards.

Specifications



Please Note: The DM54 Chimney system is zero clearance to combustible materials. Offset Blocks offer the ability to move a vertical chimney from side to side, allowing it to pass objects above the firebox. Offset blocks require 1 1/2" clearance to combustible material. "Combustibles" are defined as "normal construction materials" and are considered to be: wood framing materials, particle board, mill board, plywood sub-flooring, plywood paneling and wood flooring.

Starter Block	A	B	C
	16 1/2"	14"	6"

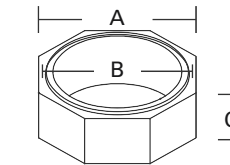

Outer Casing	A	B	C
	21 1/2"	21 1/2"	12"

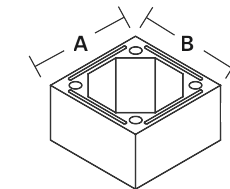

Inner Flue Liner	A	B	C
	16 1/2"	14"	12"

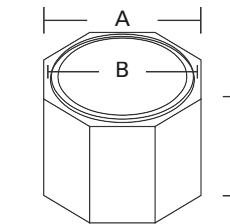

Brickledge	A	B	C
	31 1/2"	31 1/2"	3"

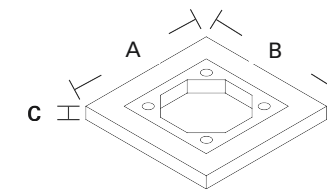

Small Crown Cap	A	B	C	D
	26 1/4"	26 1/4"	1 1/4"	3"

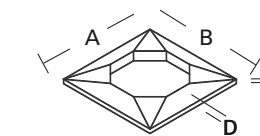

Large Crown Cap	A	B	C	D
	37 1/2"	37 1/2"	1 1/4"	3"

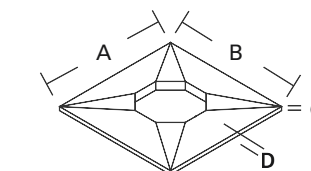

Offset Block	A	B	C	D	E
	21 1/2"	25"	11"	3"	6"

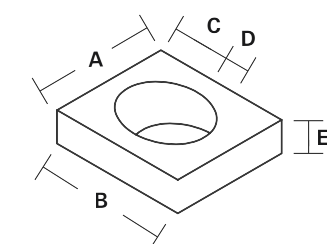

Isocaps

Specifically designed by Earthcore for the Isokern DM54 flue liner, Iso-Cap installation is minimal. Sealed with silicone caulk, each Iso-Cap simply slides into or over the inner flue liner of the DM54 Chimney.





Isokern Chimney Systems have vented over 155 million meters of chimney in North America.

Our 16" Diameter EM 40 Universal Flue is the largest insulating masonry chimney available. With proprietary "Air-Vent" technology, it will not crack like cheaper concrete alternatives. Used exclusively for outdoor applications. It requires a 2" clearance to combustible materials.

Fireplace & Chimney Accessories



EM 40 Mono Flue Cap

Specifically designed for the Isokern 16" EM-40 Mono Flue, this Stainless Cap is easily installed. This cap slides on top of the EM-40 Mono Flue.

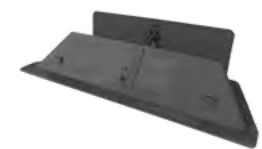

Cast Iron Damper

This Cast Iron damper is designed to sit in the throat of the Isokern fireplace and can be opened and closed with the poker control. Sizes Available: 33", 42", 60" & 72"

HIGH-TEMP FIBERGLASS GASKET



Sealed Cast Iron Damper

Our New Sealed Cast Iron dampers substantially prevent air from escaping the chimney while also preventing outside air from entering the home. This damper utilizes a high temperature fiberglass gasket to form a tight seal, offering energy efficiency for masonry fireplaces without the use of glass doors or chimney top dampers. Sizes Available: 33" & 42"



Bottom Mount Damper

The Bottom Mount Damper is a proprietary design to be used when a conventional poker or top-mount damper is not feasible. Great with see-through applications, this type of damper can be paired with either the DM54 or Steel Chimney Systems.

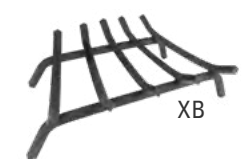

Cast Iron Grates

Stop struggling with fireplace grates that don't hold logs in the right location in your fireplace and have poor ventilation. With these Cast Iron Fireplace Grates in your fireplace, those concerns will be a thing of the past!

XB SIZES AVAILABLE: 24", 30", 36" HL SIZES AVAILABLE: 23", 27"



Earthcore Isokern Adhesive

The Earthcore Adhesive, is a thin-set masonry adhesive, which can be used in either interior or exterior installation. Properly mortared fireboxes and smoke dome assemblies require approximately five gallons (dry measure) of Earthcore Adhesive. *1 pail per 12' of DM54.*

Outside Air Kit

Our Outside Air Kits are available with 4" diameters. These kits help prevent back draft smoking caused by negative pressure in the home.



Outside Air Kit Stainless Steel Door
Part #OAKS



Outside Air Kit Matte Black Steel Door
Part #OAKB

Fireplace Enhancements



ISOKERN® Enhancements Firebrick

Firebrick Options and
Quantities for Isokern
Fireplaces



STANDARD FIREBRICK SIZES:

Fulls: 9" x 4 1/2" x 2 1/2"
Splits: 9" x 4 1/2" x 1 1/4"
Soaps: 9" x 2" x 1 1/4"*

*Red & Cream Firebrick ONLY

Make your fireplace a part of your home's decor with Isokern's Firebrick options.

Typically made of fire clay or siliceous material, our Firebrick is a refractory brick, capable of sustaining intense heat without fusion. And since it's not prone to expansion or contraction, this material helps minimize cracking under extreme heating conditions. Coloration and size varies slightly.

Available Colors:



All available in
fulls & splits.
Red & Cream
available in soaps.
Soapstone is
special order.

Pattern Guide:



IsoSet FireBrick Mortar

IsoSet Brick Mortar, a thin-set masonry adhesive, can be used in either interiors or exteriors for laying of firebrick. It is the specified firebrick mortar to be used in all Isokern Fireplaces. IsoSet is available in 50lb buckets, approximately 50 lbs of prepared mortar will lay firebrick for fireplaces up to 48".

Standard	36	42	46
	R Full/Split: 100 H Full/Split: 120	R Full/Split: 100 H Full/Split: 120	R Full/Split: 100 H Full/Split: 120
	R Soaps: 200 H Soaps: 240	R Soaps: 200 H Soaps: 240	R Soaps: 200 H Soaps: 240

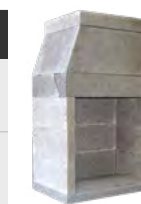

*Please Note:

4" firebrick must be used on the side walls of these units. To achieve this for the Magnum 60 & 72 models, you will need 60 additional full or split firebricks. To achieve this for the Magnum+ models, you will need 70 additional full or split firebricks.

Magnum	28	36	42	48	*60	*72
	R Full/Split: 100 H Full/Split: 120	R Full/Split: 100 H Full/Split: 140	R Full/Split: 120 H Full/Split: 140	R Full/Split: 130 H Full/Split: 150	R Full/Split: 160 & Full/Split: 60	R Full/Split: 180 & Full/Split: 60
	R Soaps: 200 H Soaps: 240	R Soaps: 240 H Soaps: 280	R Soaps: 240 H Soaps: 280	R Soaps: 260 H Soaps: 300	H Full/Split: 180 & Full/Split: 60	H Full/Split: 200 & Full/Split: 60



Magnum+	*84	*96	*108	*120
	R Full/Split: 220 & Full/Split: 70	R Full/Split: 250 & Full/Split: 70	R Full/Split: 270 & Full/Split: 70	R Full/Split: 290 & Full/Split: 70
	H Full/Split: 240 & Full/Split: 70	H Full/Split: 270 & Full/Split: 70	H Full/Split: 300 & Full/Split: 70	H Full/Split: 320 & Full/Split: 70



Maximus	46	48
	R Full/Split: 100 H Full/Split: 120	R Full/Split: 130 H Full/Split: 150
	R Soaps: 200 H Soaps: 240	R Soaps: 260 H Soaps: 300



Bvette	36	46	per extension
	R Full/Split: 100 H Full/Split: 120	R Full/Split: 100 H Full/Split: 120	R Full/Split: 20 H Full/Split: 25
	R Soaps: 200 H Soaps: 240	R Soaps: 200 H Soaps: 240	R Soaps: 40 H Soaps: 50



Vent-Free	36	42	46
	R Full/Split: 100 H Full/Split: 120	R Full/Split: 100 H Full/Split: 120	R Full/Split: 100 H Full/Split: 120
	R Soaps: 200 H Soaps: 240	R Soaps: 200 H Soaps: 240	R Soaps: 200 H Soaps: 240



ISO KERN Log Sets
Isoflames

Log sets for all vented and ventless gas burning Isokern Fireplaces

Isoflames
Vented Log Sets

The Isoflames three tiered burner system creates high and full bodied flames... while using fewer BTU's than other vented burner systems. Featuring an Indoor (Black) burner with three log set options: **Sandhill Oak, Charred Hickory or Summit Pine.** Available Sizes include: 24" & 30"

Take your fireplace's flames to new heights with Isokern's **Isoflame Log Sets.**

Our Vented and Vent-free Isoflame Gas Log Sets have lively flames and large ember beds to highlight our remarkable craftsmanship. With efficient heat and unmatched beauty, each log set comes with a flame height remote control and electric ignition.

Isoflames
Vent-Free Log Sets

Lively flames and a large ember bed highlight the handcrafted logs, adding efficient heat and unmatched beauty to your fireplace. Featuring either an Indoor (Black) or Outdoor (Stainless) burner with two log set options: **Twilight Split or Aged River Pine.** Available Sizes include: 24" & 30"

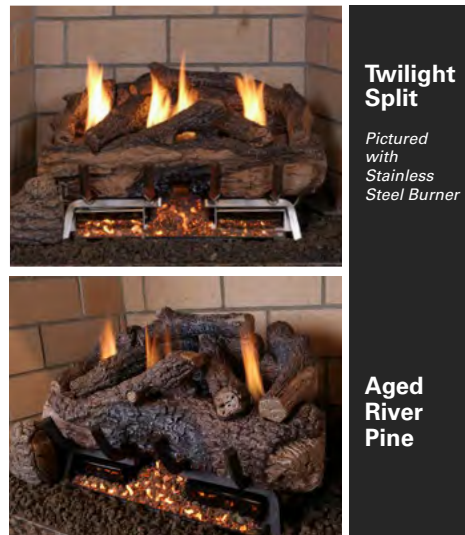
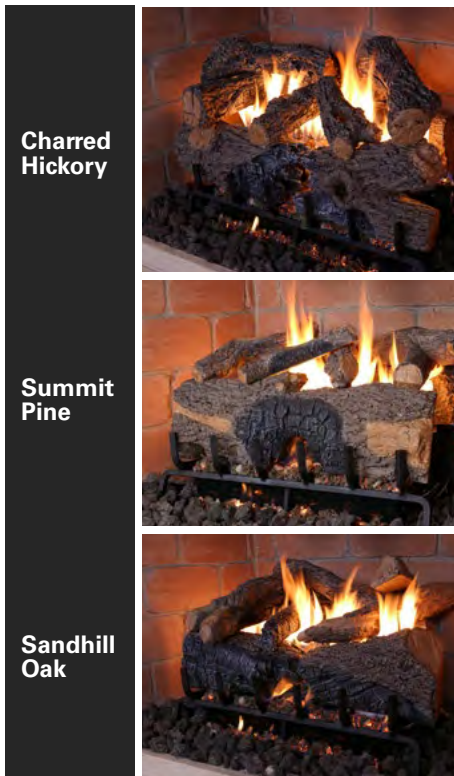

ISO KERN Log Sets
Premium

Log sets for Magnum and Standard gas burning fireplaces

Premium Gas Logs for
Magnum Fireplaces



Arizona Weathered Oak
JUMBO SLIMLINE BURNER
24" - 120"

Change the look of your fireplace instantly with **Isokern's Premium Log Sets.**

Our Premium Log Sets are individually cast and hand painted to perfection by artists creating the most realistic looking logs on the market. Found and made in America.

About
Premium Gas Logs

Whether you just need to replace your existing worn out logs or you need to convert your wood burning fire box into a gas fireplace, our Premium Gas Logs are the perfect place to start. Their life like quality dramatically increase the aesthetic appearance of your fireplace and even the burners create an ambiance of tranquility while in use. All of our products are easy to install for any licensed contractor.

Premium Gas Logs for
Magnum & Standard Fireplaces



Arizona Weathered Oak
3 BURNER SERIES
24" - 42"



Coastal Driftwood
3 BURNER SERIES
24" - 42"



Arizona Jupiter
3 BURNER SERIES
24" - 42"

ISOKERN® Enhancements
Fire-Lite

For installing Isokern Standard or Magnum Fireplaces on combustible flooring

ISOKERN® Enhancements
Green Tech

Isokern Standard or Magnum Fireplaces ONLY

Take the wonderful
ambience of fire anywhere
in your home with Isokern's
Fire-Lite Application.

Using the Metal Stand in the Fire-Lite Application, both the Isokern Magnum and Standard Series can be placed directly on a combustible floor or be recessed into any combustible floor system including hearth extension as an approved, listed application with detailed plans available.

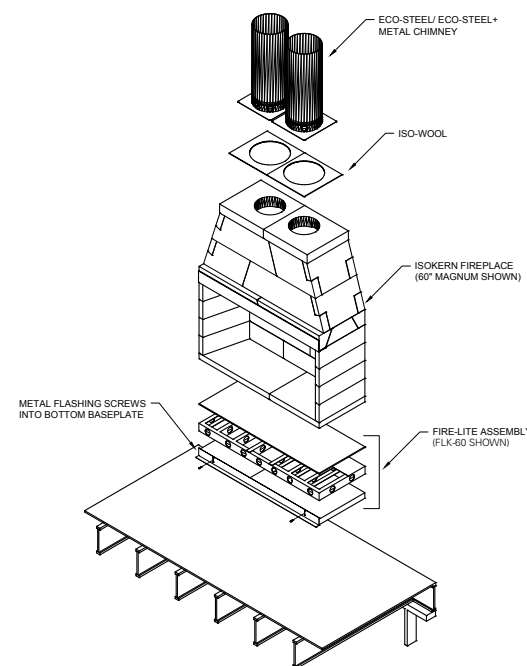

GreenTech Catalytic Combuster



Enjoy the warmth of
a wood burning fire
while contributing to a
cleaner environment.

The GreenTech Solution by earthcore can be easily installed in a matter of minutes and reduce particulate emissions by up to 80%. While your fireplace is in use, the direct flame cleans the Green Tech Catalytic Combuster, resulting in a maintenance free solution for cleaner air in and outside of your home. The Earthcore Exclusive Catalytic Combuster can be added to any Isokern Magnum or Standard Series fireplace.



Give your fireplace the finishing touch it deserves with Isokern's **European Copper Chimney Pots.**

The patented, European Copper Chimney Pots meet the highest technical standards through it's UL-Listing and compliance with International Building Codes. The European Copper chimney pots are unique in that they are compatible with both masonry and metal flue, giving you more options and a consistent quality look.

- Copper Ultramet
- Terracotta
- Weathered Copper
- Muskett
- Black



Give your venting custom style without the weight with Isokern's Elemetal Chimney Pots.

Our Decorative Steel Pots have all the appeal of our popular traditional clay pots, at a fraction of the weight and cost. Earthcore's decorative steel pots are fashioned from 24" gauge, colored, Kynar steel. They are available in five standard colors and come with a 20-year warranty.



King
 COPPER: EC-O-2447-1-CO
 GRAY: EC-O-2447-1-GR
 Weight 36 lbs | Height 48" | Base 24"



Queen
 COPPER: EC-O-2039-1-CO
 GRAY: EC-O-2039-1-GR
 Weight 26 lbs | Height 41" | Base 20"



Knight I
 COPPER: EC-SQ-2144-1-CO
 GRAY: EC-SQ-2144-1-GR
 Weight 36 lbs | Height 44" | Base 21"



Knight II
 COPPER: EC-SQ-1633-1-CO
 GRAY: EC-SQ-1633-1-GR
 20 lbs
 Height 38" | Base 16"



Bishop I
 COPPER: EC-R-2649-1-CO
 GRAY: EC-R-2649-1-GR
 47 lbs
 Height 52" | Base 26"



Bishop II
 COPPER: EC-R-2036-1-CO
 GRAY: EC-R-2036-1-GR
 36 lbs
 Height 39" | Base 20"



Pawn
 COPPER: EC-O-1924-1-CO
 GRAY: EC-O-1924-1-GR
 17 lbs
 Height 25" | Base 20"



Glasgow
 PROD# ROU3026
 46lbs
 32" H | 28" Inside Diameter



Ontario
 PROD# SQOCT-1932
 37lbs
 38" H | 21" Inside Diameter



Portsmouth
 PROD# OCT1930
 37lbs
 36" H | 21" Inside Diameter



Dorchester
 PROD# SQ-2326
 46lbs
 32" H | 21" Inside Diameter





ISO KERN Enhancements
EcoSteel & EcoSteel+
 For Installation of Isokern Standard, Magnum & Magnum+ Fireplaces



The Lightweight Venting Solution that uses a locking-tab design, ensuring immediate and tight assembly.

With a 12 5/8" inner diameter and a 15 5/8" outer diameter, it is rated for any solid fuel Isokern Fireplace. This versatile system has been tested and approved for use with Isokern Standard and Magnum fireplaces in typical OR Fire-Lite applications. Available in air-cooled (EcoSteel) or insulated (EcoSteel+).

EcoSteel	
	Air-Cooled Chimney Flue 6" - 13ACECO6 12" - 13ACECO12 18" - 13ACECO18 36" - 13ACECO36 48" - 13ACECO48
	Air-Cooled Anchor Plate 13ACECOAP
	Air-Cooled Anchor Plate with Damper 13ACECOAPD
	Air-Cooled 15° Offset 13ACECO15OS
	Air-Cooled 30° Offset 13ACECO30OS

EcoSteel+	
	Insulated Chimney Flue - Stainless Steel 6" - 13INECO6 12" - 13INECO12 18" - 13INECO18 36" - 13INECO36 48" - 13INECO48
	Insulated Anchor Plate - Stainless Steel 13INECOAP
	Insulated Anchor Plate with Damper - Stainless Steel 13INECOAPD
	Insulated 15° Offset - Stainless Steel 13INECO15OS
	Insulated 30° Offset - Stainless Steel 13INECO30OS

EcoSteel & EcoSteel+					
	Round Chimney Cap Stainless Steel 13ACECOCC		Tall Cone Flashing 13ACECOFT		Firestop Assembly Stainless Steel 13ACECOFS
	Chase Flashing 13ACECOFC		Support Band 4 pack 13ACECOSB		Attic Insulation Shield 13ACECOIS
	Rain Cap for Shroud Installation 13ACECORC		Storm Collar 13ACECOSC		Adjustable Support 13ACECOAS
	Wall Band 13ACECOWB		1/12 to 5/12 Flashing 13ACEOF		6/12 to 10/12 Flashing 13ACEOF10

Outdoor Solutions



ISOKERN® Outdoor Isopanel

Modular panels for the construction of outdoor kitchens



ISOKERN® Outdoor Iso'ven

Modular wood-fired oven for outdoor use or in the construction of outdoor kitchens



CLIP STYLES:

Use: Slide the appropriate clip over the junction of 2 adjacent panels for holding them together while the mortar is applied.

1



45° Clip

2



"T" Clip

3



Straight

4



90° Clip

Earthcore has streamlined the construction of building the classic culinary outdoor kitchen for quick assembly.

Using our Isokern Panels and Clips, building a beautiful, durable and practical outdoor kitchen is easier than ever. The Isopanel will also support the Iso'ven for added options to construction.



Isokern Panels Components

Each panel weighs only 100 lbs, so they're easily moved when assembling your new outdoor kitchen components.



ACCESSORY KIT

Experience the simple joys of fire in the easiest way imaginable. Enhance your cooking pleasure with the Iso'ven Accessory Kit, which includes a wide array of tools specifically for cooking with your Iso'ven Wood Burning Pizza Oven.



Includes:

1. Utility Tong
2. (2) 12" Pizza Screens
3. 26" Pizza Peel
4. Stainless Steel Mixing Paddle



The user-friendly, remarkably affordable outdoor wood burning pizza oven made from our exclusive volcanic material.

Created for easy installation, the Iso'ven Wood Burning Pizza Oven comes with everything you need to get started, including an accessory package of helpful cooking tools.

Optional Storage Base



The ideal companion for your Iso'ven Wood Burning Pizza Oven — our Optional Storage Base. It allows you to choose the height of your Iso'ven in relation to the rest of your outdoor kitchen or living space. Installed as-is, with no customization, our Iso'ven base is the perfect height to pair with one of our Isokern outdoor fireplaces.

Oven Hood



Following the classic approach of traditional wood burning ovens, the Iso'ven is designed to vent through the front. But at Earthcore, we believe customization creates satisfaction. So, if you prefer a flue, we now offer a Hood for Iso'ven designs, giving you the freedom to finish it in your own personal style.

ISOKERN[®] Outdoor Kitchens





Possibilities for outdoor
kitchens with Isopanel,
Isoven & Magnum
Isokern

We know the possibilities are limitless when it comes to building your outdoor Dream Kitchen with our Isopanel.

That's why we've put together a few examples for you to choose from, along with specifications and installation materials needed.



A. Linear Kitchen with Isopanel Kitchen

What You'll Need:

-  11 - ISOPANEL Kitchen Panels
-  2 - τ-Clips
-  4 - STRAIGHT Clips
-  4 - 90° Clips
-  2 - EARTHCORE Adhesive Buckets

B. Iso'ven with Isopanel Kitchen

What You'll Need:

-  1 - ISO'VEN with pizza hood
-  24 - ISOPANEL Kitchen Panels
-  6 - τ-Clips
-  8 - STRAIGHT Clips
-  4 - 45° Clips
-  8 - 90° Clips
-  5 - EARTHCORE Adhesive Buckets

C. The Magnum with Isopanel Kitchen

What You'll Need:

-  1 - ISOKERN 48 Magnum
-  28 - ISOPANEL Kitchen Panels
-  6 - τ-Clips
-  8 - STRAIGHT Clips
-  4 - 45° Clips
-  8 - 90° Clips
-  5 - EARTHCORE Adhesive Buckets
-  130R/260H FireBrick
-  2 - ISOSET Mortar Buckets
-  6 Sections - EM 40 Mono Flue
-  1 - EM 40 Mono Flue Cap

A

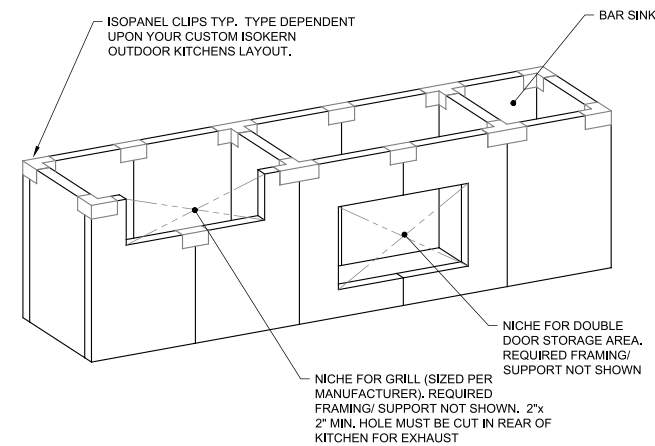

B

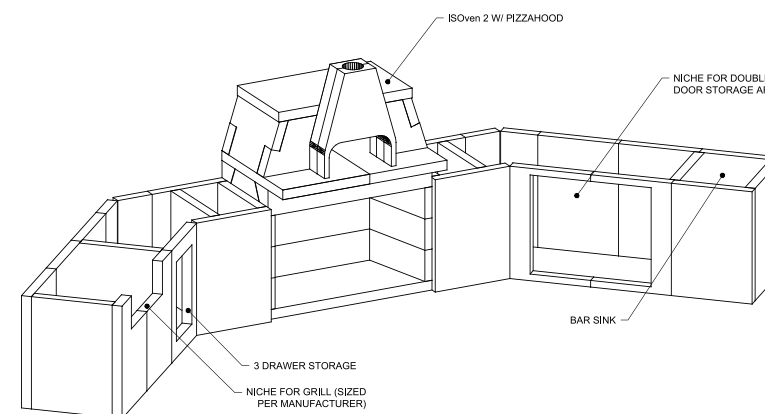

C

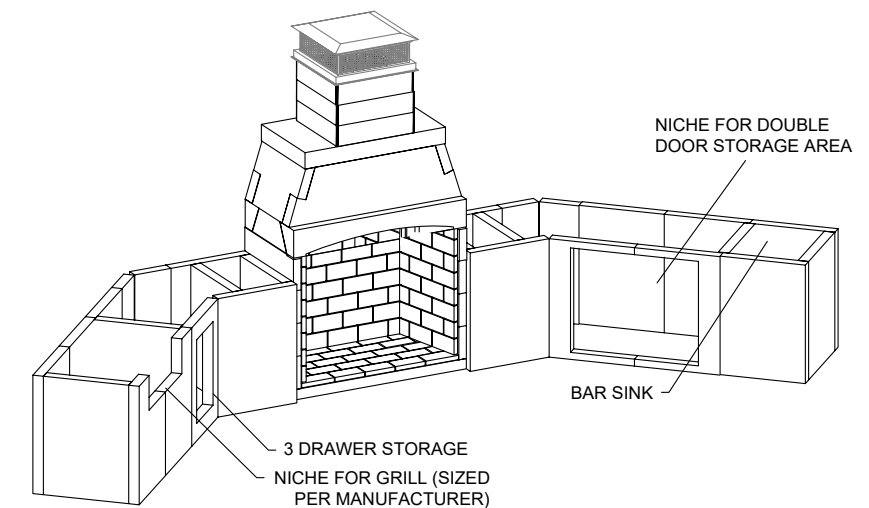

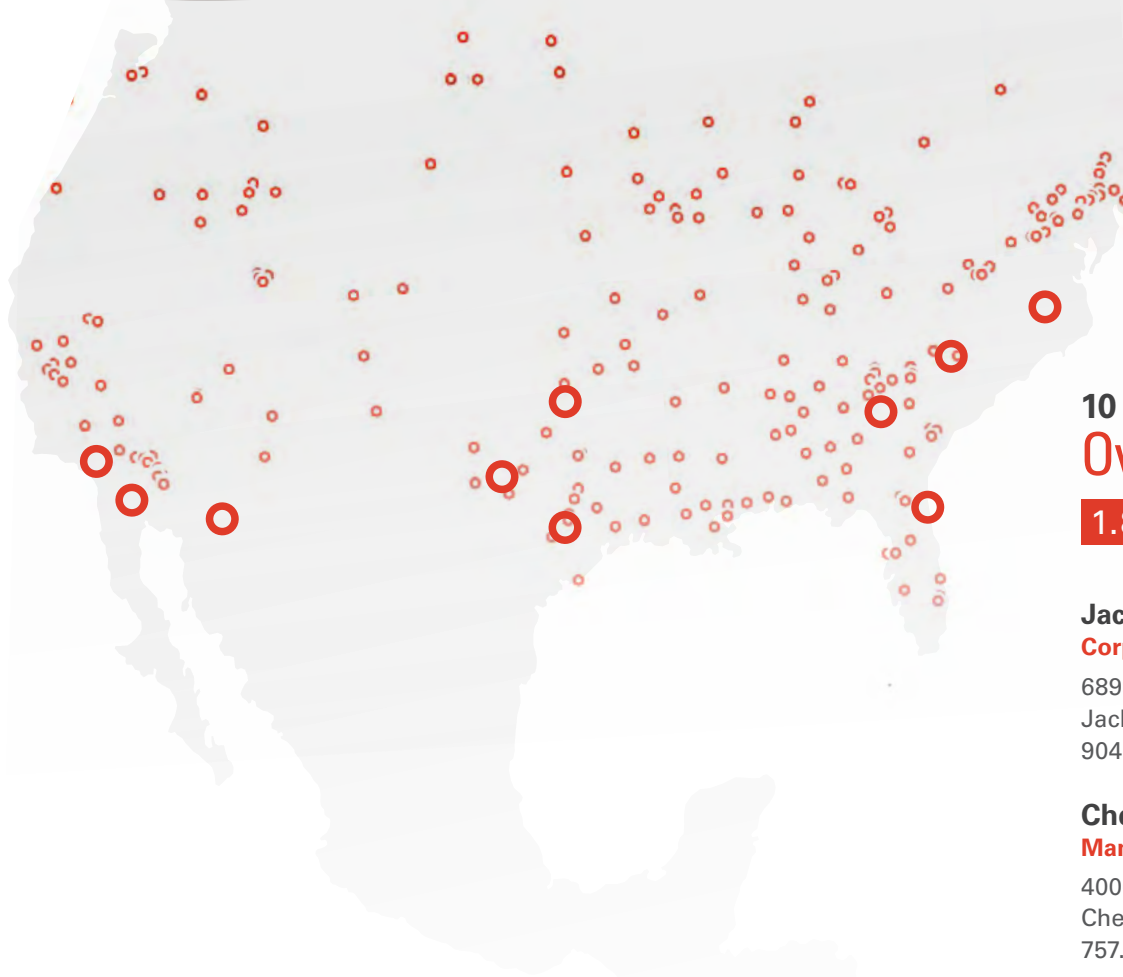

10 Office locations
Over 400 Dealers.

1.800.642.2920

Jacksonville, FL

Corporate / Branch Office

6899 Phillips Industrial Blvd.
Jacksonville, FL 32256
904.363.3417

Chesapeake, VA

Manufacturing / Distribution

4000 Holland Blvd.
Chesapeake, VA 23323
757.966.7275

Corona, CA

Warehouse / Distribution

620 W Rincon Street
Corona, CA 92880
951.738.9702

earthcore.co