



Ceramic
ventilated facades
KeraTwin® | KeraShape®

architectural
ceramics

DEUTSCHE
STEINZEUG  **AGROB BUCHTAL**

The In-house Planning Department or certifications are just two of many good reasons.

As specialist for architectural ceramics, AGROB BUCHTAL offers an extensive portfolio of products and services for modern and future-oriented building and designing with ceramics. The company's history already started in the 18th century. Today, AGROB BUCHTAL is a global player deeply rooted in Germany as traditional location.



In-house Planning Department. Specific relief of routine tasks opens up creative scope for specialists who convince in the form of their solutioncompetence and offer technical building consulting on site.



Design. In cooperation with architects, new and individual products as well as special solutions are continuously being created. With renowned product designers, AGROB BUCHTAL also develops new color concepts and surfaces that take up current trends in architecture.



Digital print. Modern technology creates facades in line with individual requirements. Accordingly, apart from wood or stone looks exuding a natural effect, metallic glazes are also possible which are resistant to environmental factors.



Experience. The innovative strength is based on know-how gleaned by several generations – extending as far back as the 18th century. By offering ceramic facade systems, the specialist for architectural ceramics has been making a name for itself all over the world for more than 40 years.



Colors. The enormous selection of colored glazes includes the harmoniously co-ordinated SpectraView color families as well as a wide range of design surfaces, as glazed or unglazed variants. On request, special colors are also developed to ensure maximum freedom of design.

Freedom of design. Additional possibilities associated with individual facade design arise from the use of various formats and surface finishes. Textured facade panels can loosen up expansive areas, for example, and emphasise the character of an entire building.



Ceramics. As a building material which has proved its value for thousands of years, ceramics displays ideal properties: it is non-combustible, resistant to chemicals, light-fast, resistant to pressure, impact and scratches, easy-care and hygienic.



Made in Germany. Modern production facilities, expertly-trained employees and efficient Quality Management are the basis for high-quality products. Ceramic facade systems offered by AGROB BUCHTAL are subject to on-going inspections and are manufactured exclusively in Germany. For guaranteed “Quality made in Germany”.

Sustainability. Ceramics is harmless in terms of building biology. It scores well on account of its unlimited useful life and can be fully recycled.



Surface finishes. The innovative HT surface coating prevents the formation of algae, moss and microbes while the self-washing effect ensures permanently clean facades.



Special solutions. More than 20,000 glaze formulations, digital printing technology and other individual solutions open up unlimited possibilities for design – for new buildings and in stylish renovations of protected buildings.



Cost-effectiveness. Perfect substructures guarantee efficient panel installation. The low panel weight offers advantages in terms of statics, transport and handling.

Certifications. All systems are tested by the Buildings Inspectorate. Specialized product information supporting the auditors facilitates and accelerates certifications in accordance with LEED, DGNB and BREEAM.

The perfect solution: Curtain-type, rear-ventilated ceramic facades

Aesthetics, economic efficiency and sustainability: the combination of these three factors is the basis for the growing success of curtain-type, rear-ventilated ceramic facades. The decisive reason for the technical superiority of these systems is the structural separation of the functions of heat insulation and weather protection.

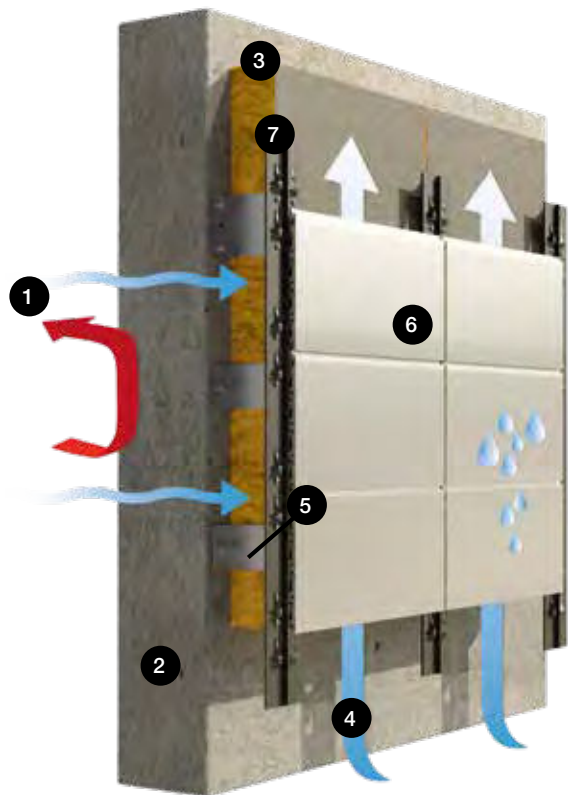

System: structure and function

Thanks to the air space between the outer facade cladding (ceramics) protecting the building against snow and rain and the insulation (mostly mineral wool), curtain-type, rear-ventilated facade systems improve the indoor climate, save heating costs and conserve natural resources.

- 1 Moisture is carried away
- 2 Anchoring base
- 3 Mineral insulation
- 4 Rear ventilation ≥ 2 cm
- 5 Wall bracket
- 6 AGROB BUCHTAL ceramics
- 7 Bearing profile

The ventilated cavity between the ceramic panels and insulating material regulates the building's moisture balance, directing moisture outwards and guaranteeing swift drying of damp exterior walls. The insulating material stays dry and fully functional while the indoor climate is improved.

Regardless of the building height and utilisation, mineral insulating materials are usually used for rear-ventilated ceramic facades. As the system permits installation of any thickness of insulation material, the specifications of the Energy Savings Ordinance can also be easily met. The permanently safe connection between ceramic panels and supporting outer wall is ensured by the substructure where sophisticated constructions make for efficient installation and compensate for uneven surfaces on the walls. In addition, aluminium substructures play a key role when it comes to lightning protection.

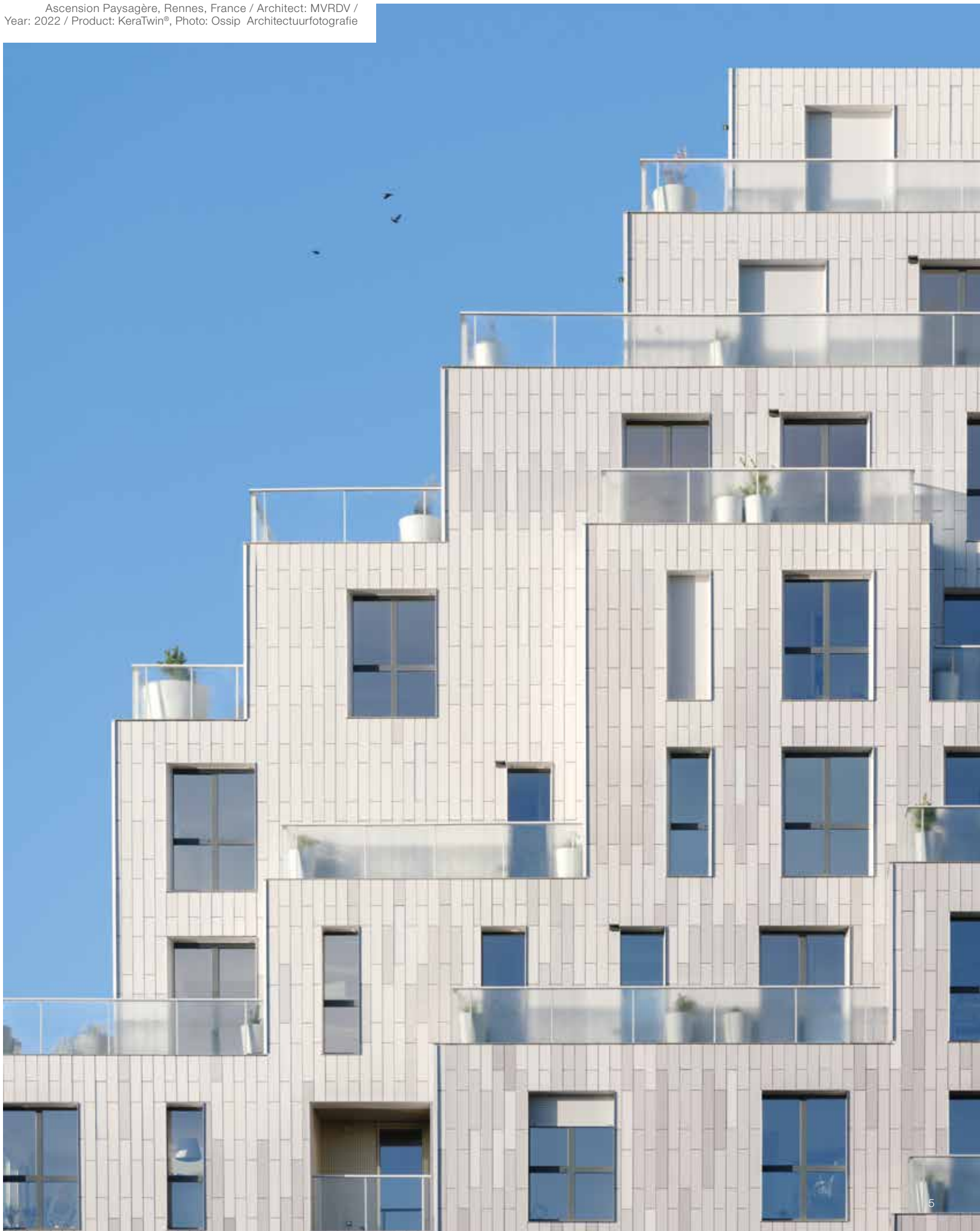





Ceramic facades: Distinctive shell withstands time and weather

Sustainability and conservation of resources also play an increasingly important role when it comes to planning and designing facades. As the panels are resistant to frost, light- and color-fast, non-combustible and very impact-proof, they have a practically unlimited useful life. Whether glazed or unglazed, the highly-resistant surface made of fired ceramics makes them resistant to extensive soiling such as graffiti. And the Hytect surface with its self-washing effect also reduces cleaning requirements. They are not only efficient, sustainable and cost-effective to install, but as mature systems they also meet even the most stringent safety requirements, both for new buildings and for refurbishments. Especially, in the fulfillment of fire protection requirements ceramic facade elements can score points.

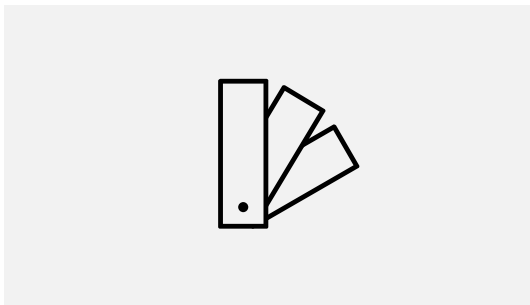

Variety of design

Curtain-type, rear-ventilated facades permit facade design which is independent of the building grid. With a wide selection of materials and sizes and an extensive range of harmoniously co-ordinated colors in various surface finishes, planners and architects have plenty of scope for implementing their ideas. Accordingly, the function and character of the building can be emphasised, attention drawn to significant components or surrounding colors integrated in the design.

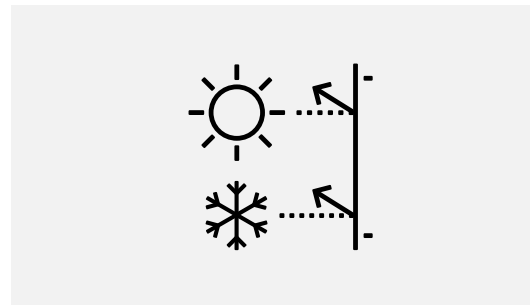

Protection against heat and cold

In combination with mineral insulating materials and an innovative substructure, curtain-type, rear-ventilated facades can achieve any U-value. This ensures good insulation and low heat loss in winter yet good indoor climate conditions in summer. Energy requirements for heating and cooling are reduced. Furthermore, ceramics displays practically no temperature-induced linear expansion – unlike other materials such as metal or composites.

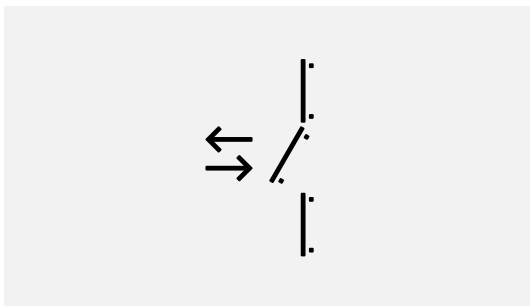

Replacing individual panels

In the event of damage or for any other reason, individual or several panels can be easily removed and replaced without any major effort.

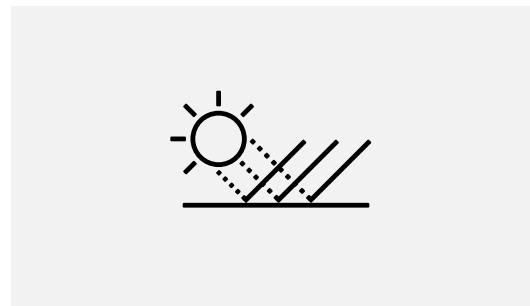

Light- and color-fast

Fired at high temperatures of over 1,200 °C, environmental factors such as heat, cold and solar radiation (UV light) do not have any lasting effect on surface appearances. Colors remain unchanged even after several decades.

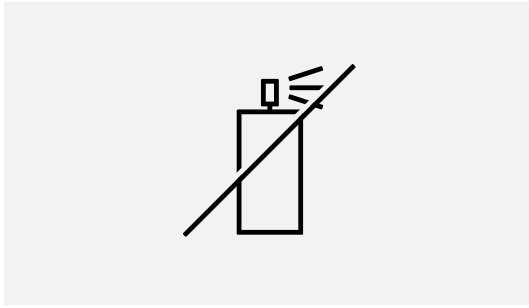

Anti-graffiti

Acade ceramics by AGROB BUCHTAL meet the requirements on cleaning according to ReGG III of the Gütegemeinschaft Anti-Graffiti e.V., whereby the maximum performance class is achieved. This has also been confirmed by an independent test institute.

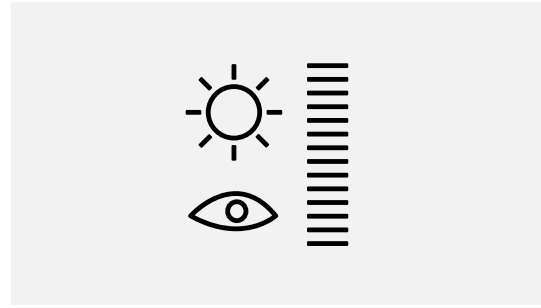

Sun and visual protection

Solar protective equipment mounted on the outside is most effective in reducing the energy input via translucent layers. Rear-ventilation also offsets surface heating.

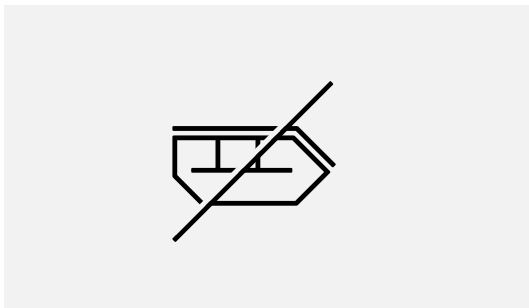

Less waste on site

As the ceramic elements are robust and resistant to weathering factors such as rain and frost, they do not require complex packaging but are secured on standard pallets for delivery to the building site. This accelerates on-site processes and means that little waste is incurred which, in turn, needs to be disposed of.

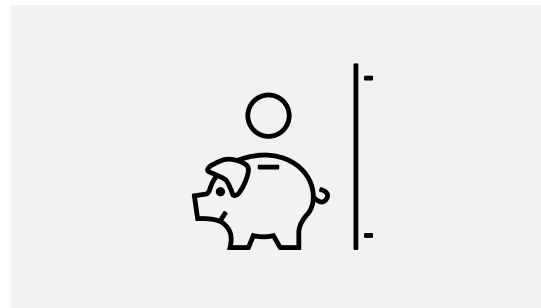

Economic feasibility

The curtain-type, rear-ventilated facade design protects the components underneath against a wide variety of environmental factors. This results in a long useful life on the part of the entire construction, low susceptibility to damage, comparably low maintenance costs, cost stability during the planning phase, and installation independent of the weather.

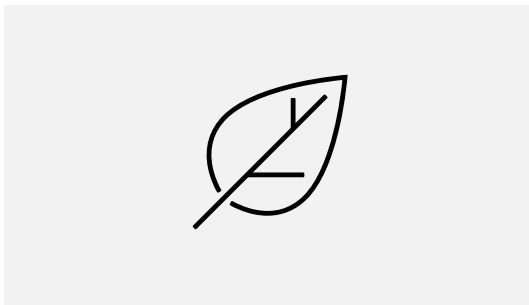

Sustainability

Ceramic facades are suitable for both new buildings and renovations, and permit a lengthy useful life or extend the useful life of existing buildings. The Hytect surface with a selfwashing effect supplied by AGROB BUCHTAL ensures a low cleaning effort and improves the quality of air in the vicinity of the building. All components can be easily recycled after de-construction.

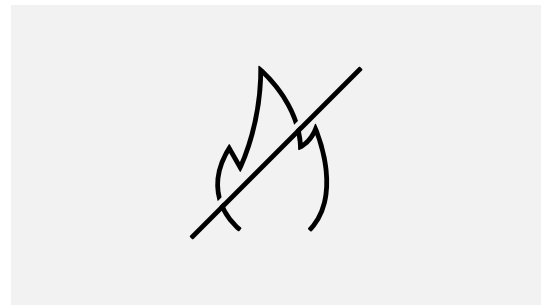

Fire safety

Fire safety experts rate curtain-type, rear-ventilated facades as very safe in terms of technical fire safety. Free selection of the system components makes it possible to meet all technical fire safety requirements. As a general rule, the following applies: all components of curtain-type, rear-ventilated facades must be made of non-combustible materials. The DIN 18516-1 in conjunction with Annex 2.6/4 of MLTB regulate fire safety for curtain-type, rear-ventilated facades. Detailed information on measures, precautions and rules can also be found in the applicable state construction laws of the 16 German states (LBO), in the general DIN and VDE provisions as well as in the information provided by building supervision.



Downing Students City Village, Belgrade Plaza, Coventry, Great Britain /
Architects: Simpson Haugh and partners group / Year: 2017 /
Product: KeraTwin® / Photo: Simon Kennedy



KeraTwin®: Ceramic system

With its variety of colors, formats and surface finishes, KeraTwin® offers the architect enormous freedom of design. And as diverse fastening alternatives ensure technical and structural versatility, this system offers the appropriate solution to any challenge.

The panels can be arranged horizontally or vertically as well as in different configurations. Installation is possible on almost all substrates, including ceilings – and all of this all in one panel geometry and one panel thickness.



System rail / T-profile



Omega-profile



OmegaS-profile



OmegaV-profile

Advantages for facade designers

- Very good assembly and adjustment possibilities thanks to separate basic and system profiles
- Fastening elements in the height grid are already integrated in the system profiles
- Easy assembly at connection points, e.g. corners, soffits etc.
- Very fast assembly of panels
- Easy to replace or subsequently install individual panels
- No basic profile required as the fastening elements are already integrated in the K20 T-profile height grid
- Flexible fastening
- Tension-free fastening to smooth surfaces is possible



Clamp system

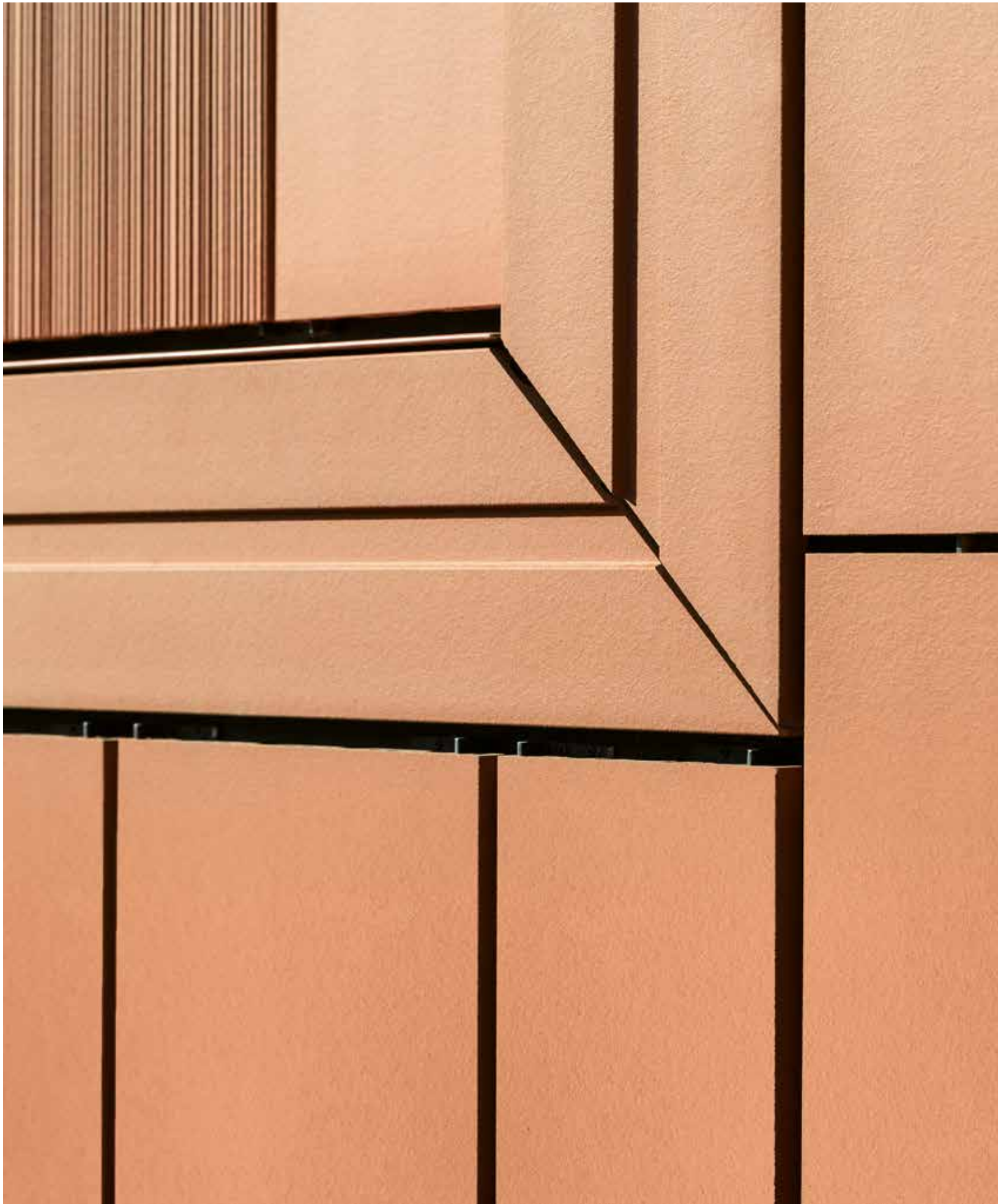

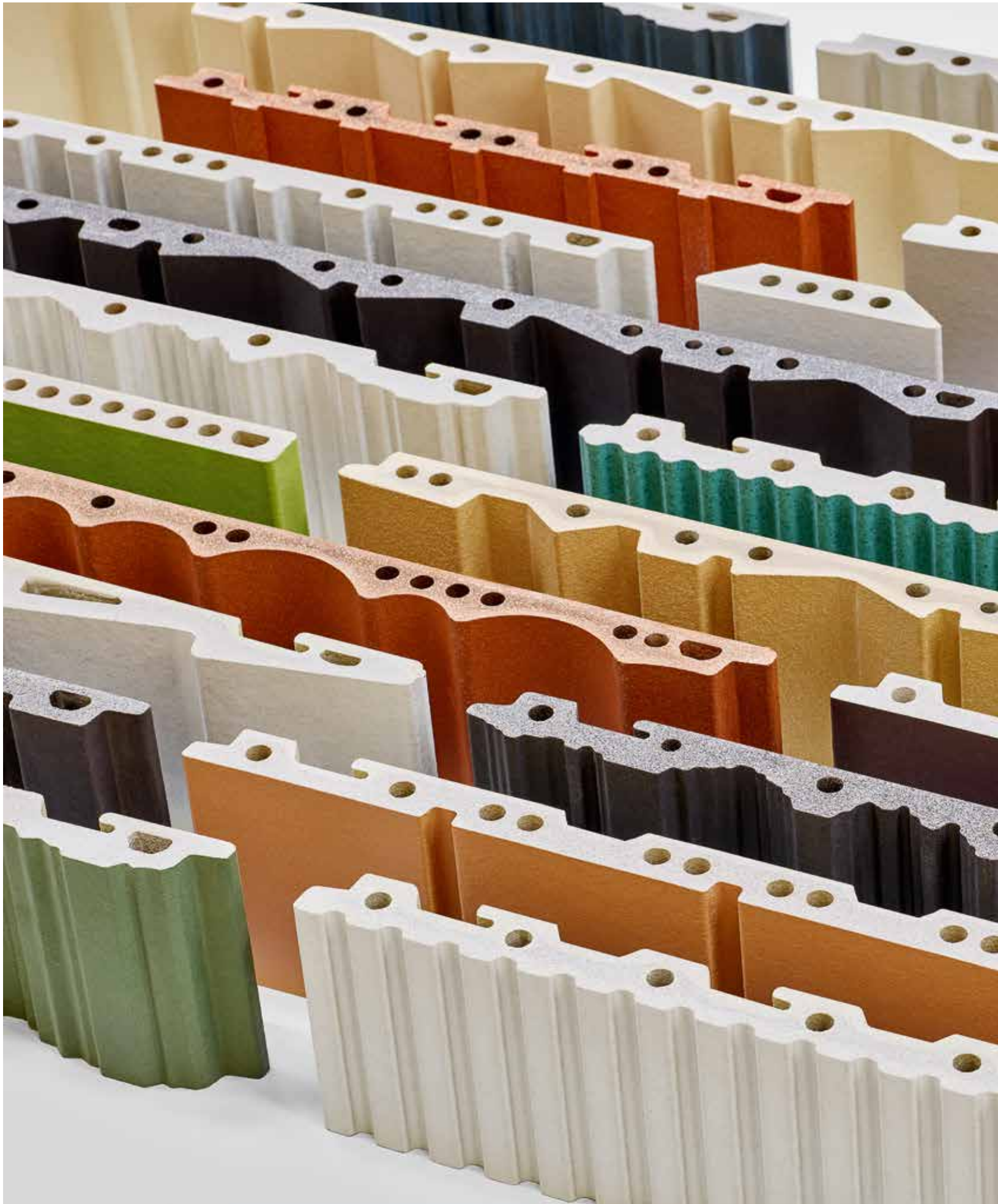

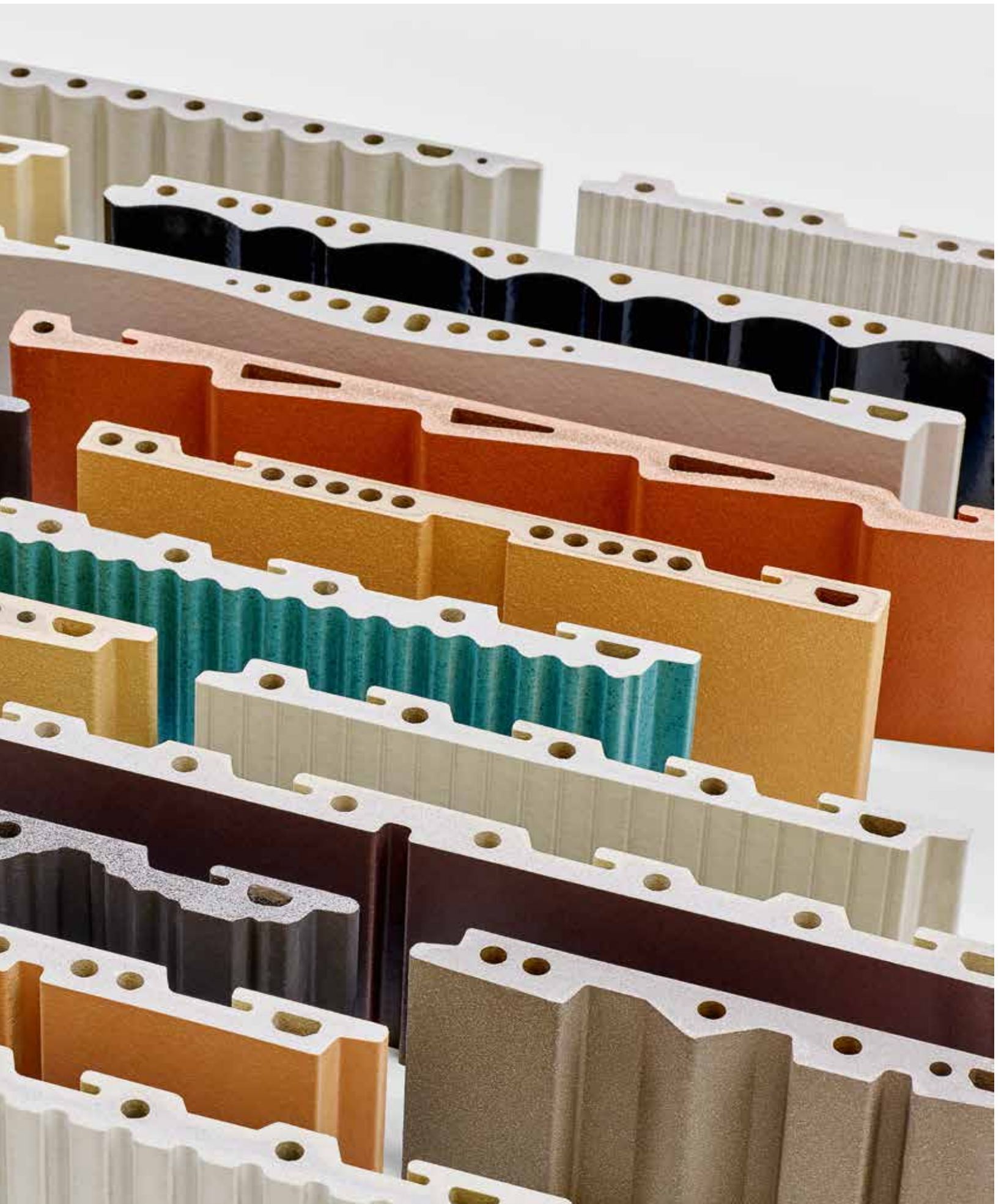

KeraTwin®

Surfaces and formats

The particularly efficient laying and practically unlimited application possibilities thanks to diverse fastening systems speak in favour of KeraTwin®.

KeraTwin® K20



Smooth (standard)



Grooved panel



Grooved panel positive



Stripy pattern



Shed profile



Brushed surface



Sine wave



New Wave



Panel with irregular grooves



Canyon



Kaijo

The cross sections shown are not available in all height grids and color variations. The feasibility is checked on a project-specific basis.

KeraTwin®, Extruded Ceramic Panels, Precision, with an average water absorption of $3\% < E \leq 6\%$, group All_a, part 1, annex B, glazed (GL) and unglazed (UGL)

KeraTwin®, Extruded Ceramic Panels, Precision, with an average water absorption of $6\% < E \leq 10\%$, group All_b, part 1, annex D, glazed (GL) and unglazed (UGL)

Lengths of up to 1,800 mm (in 1 mm steps)

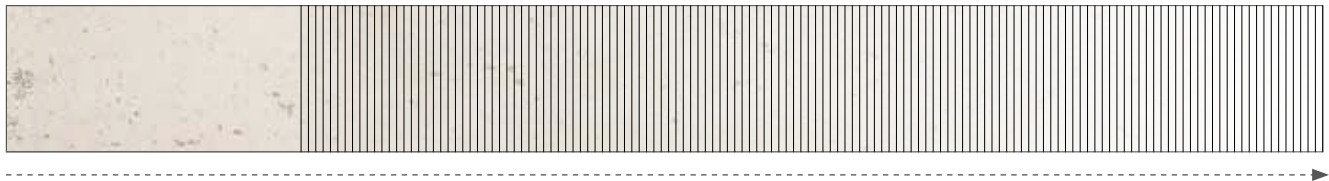

Length	up to 900 mm	up to 1,200 mm	up to 1,500 mm	up to 1,800 mm
Height	150 mm 175 mm	200 mm 225 mm	250 mm 275 mm	300 mm 325 mm 350 mm 375 mm 400 mm 450 mm 500 mm 550 mm 600 mm

Schematic diagram: production-related deviations possible in individual cases; exact panel cross-section on request.

In addition to the variants shown, other, individual developments are possible on request. The technical realization of the color design partly depends on the cross-section geometry. We will check this on request. Due to the different panel cross-sections, the choice of the fastening system depends on the individual case. Furthermore, color deviations compared to the standard variants can not be excluded.

KeraShape®

Forms and formats

With its diverse profiles, KeraShape® fulfils numerous functions – from the protection against the sun and view to the three-dimensional design of facades.

KeraShape® „Extruded Ceramic Panels, Precision, with an average water absorption of $3\% < E \leq 6\%$, group All_a, part 1, annex B, glazed (GL) and unglazed (UGL)“

KeraShape® „Extruded Ceramic Panels, Precision, with an average water absorption of $6\% < E \leq 10\%$, group All_b, part 1, annex D, glazed (GL) and unglazed (UGL)“



Rectangular tube
50 x 60 mm / 60 x 60 mm
Work size: 50 x 60 mm / 60 x 60 mm
Weight: 50 x 60 mm: 4.29 kg/lin. m.
60 x 60 mm: 4.49 kg/lin. m.
available unglazed as well as with 4 glazed sides. Possible up to a length of 1,800 mm on request

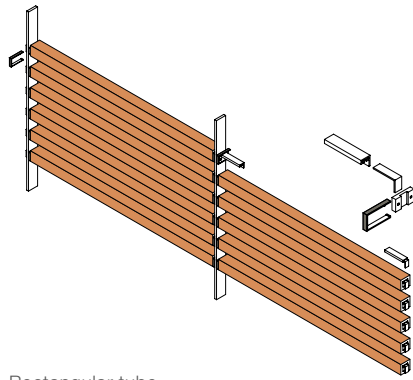

Rectangular tube

Cross-section of rectangular tube



Rectangular tube
50 x 100 mm*
Work size: 50 x 100 mm
Weight: 6.84 kg/lin. m.
available unglazed as well as with 4 glazed sides. Possible up to a length of 1,500 mm on request

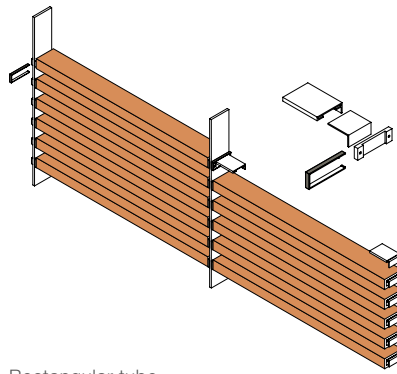

Rectangular tube

Cross-section of rectangular tube



Lamellar element
Work size: 140 x 60 mm
Weight: 9.00 kg/lin. m.
possible up to a length of 1,200 mm, available only unglazed

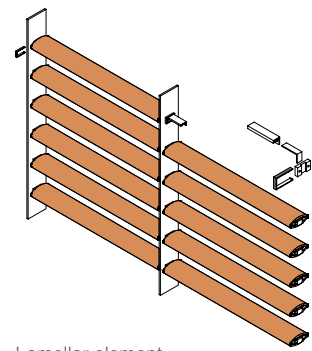

Lamellar element

Cross-section of lamellar element

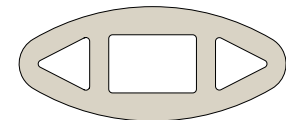

In addition to the variants shown, the production of individual articles is also possible. After a short check of the individual case for technical and economical feasibility, we will be pleased to provide you with project-specific information.

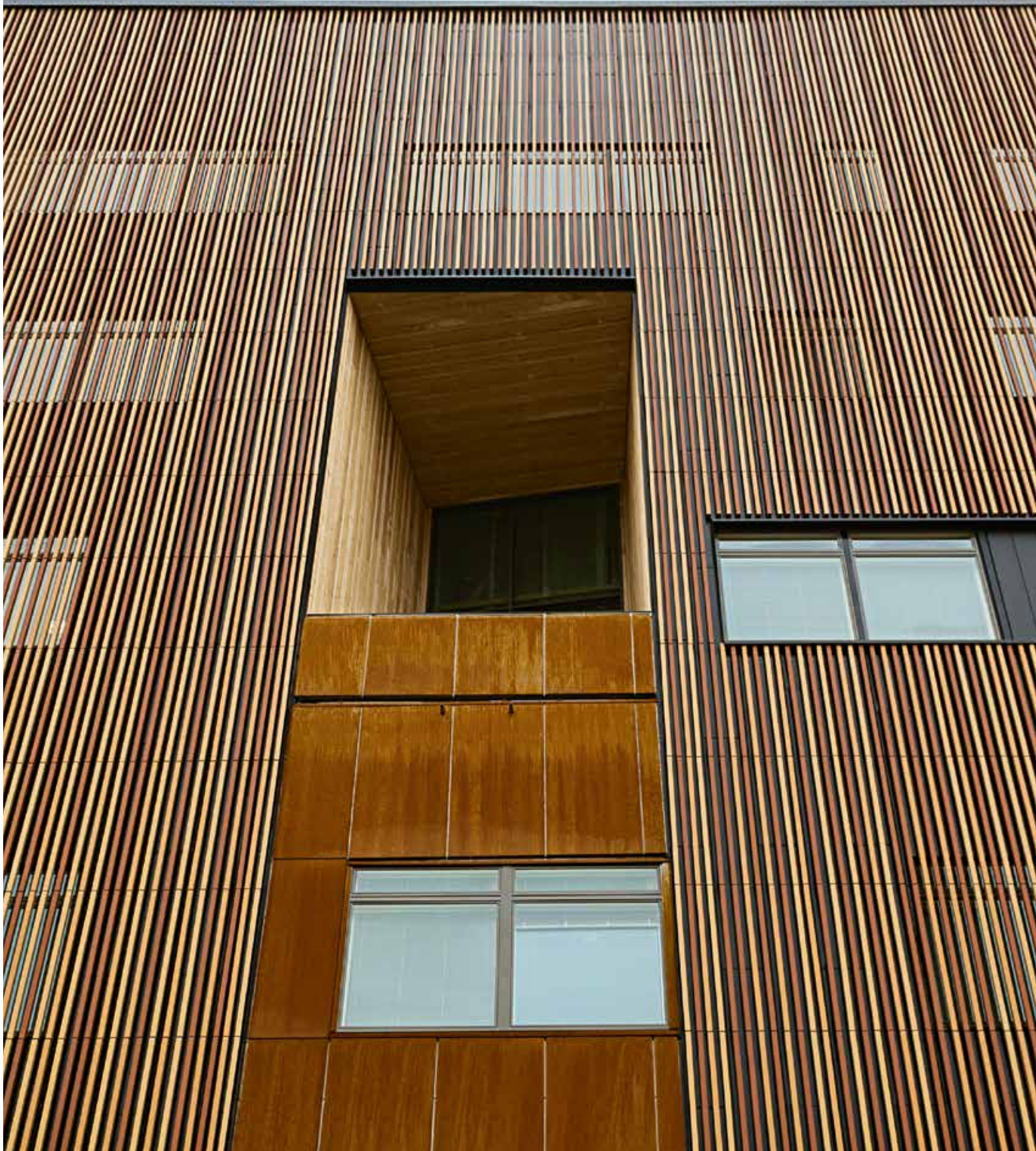



StudyQuarters in the Science Park® in Osnabrück, Germany /
Architect: PLAN.CONCEPT Architekten GmbH, Osnabrück / Year: 2020 /
Product: KeraShape® / Photo: Jochen Stüber, Hamburg



KeraTwin® | KeraShape® Colors

SpectraView

glazed, silky-matt

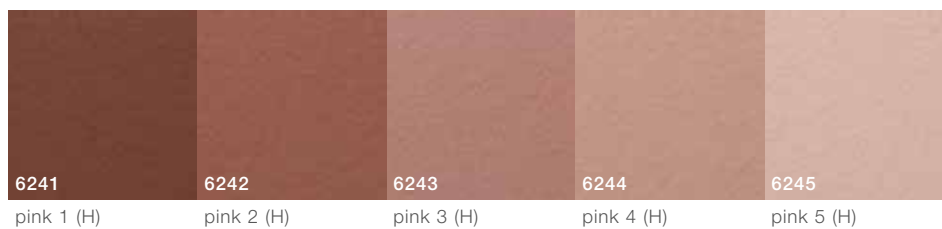
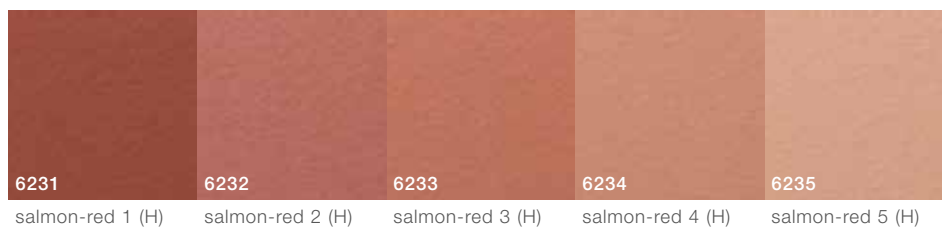
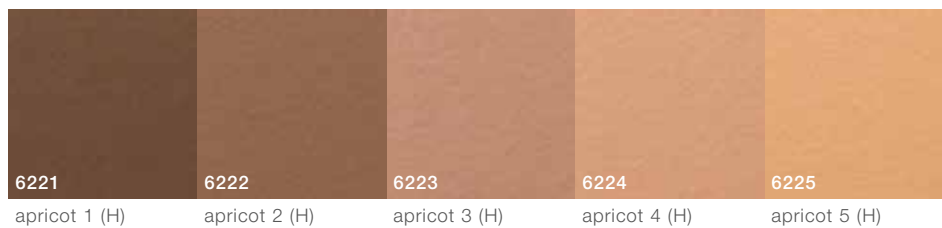
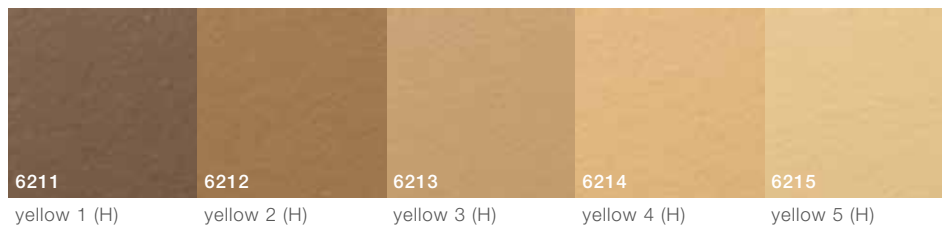
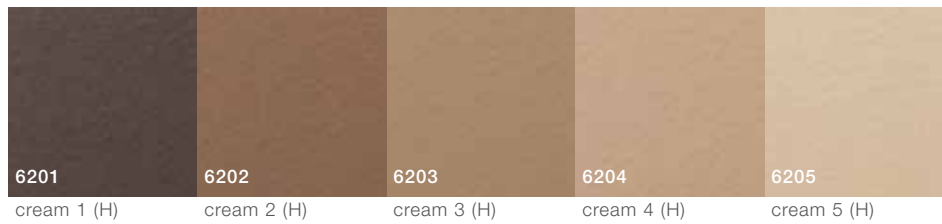

(H) = Hytect surface

KeraTwin® panels have the Hytect surface. With KeraShape® this surface finish is not available due to the difference of the production method.

In addition to the variants shown, the production of individual articles is also possible. After a short check of the individual case for technical and economical feasibility, we will be pleased to provide you with project-specific information.

Contrasting colors

glazed, glossy

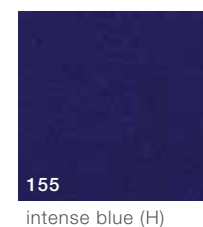
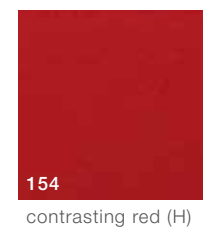
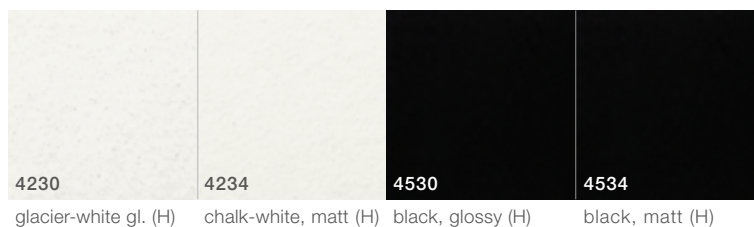
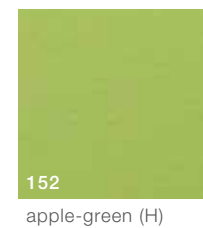
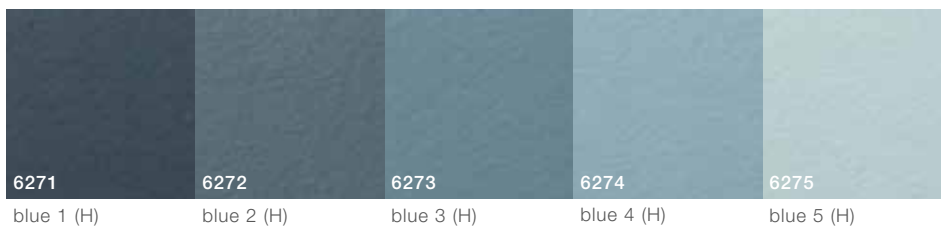
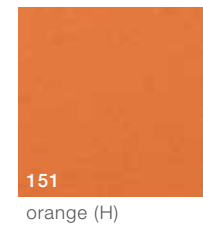
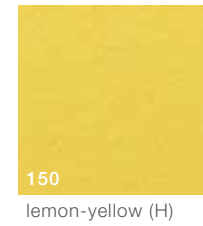

KeraTwin® | KeraShape®

Colors

Natura

unglazed

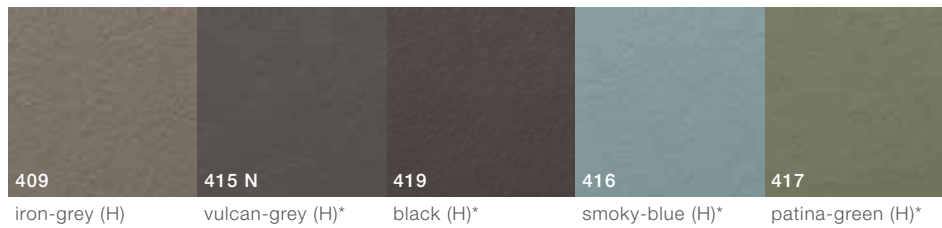
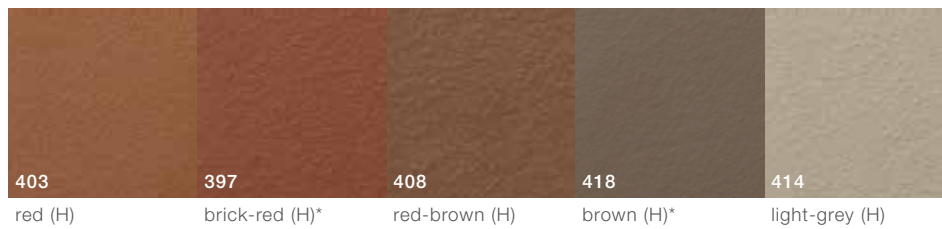

* Not available as molded piece lamella.



(H) = Hytect surface

KeraTwin® panels have the Hytect surface. With KeraShape® this surface finish is not available due to the difference of the production method.

In addition to the variants shown, the production of individual articles is also possible. After a short check of the individual case for technical and economical feasibility, we will be pleased to provide you with project-specific information.

KeraTwin®

Design surfaces

Design

glazed

Stone

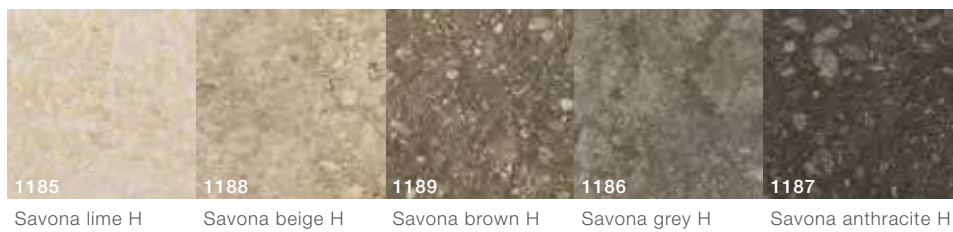
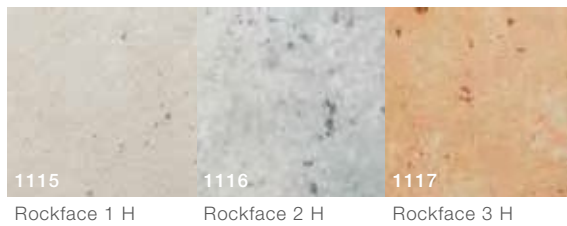

KeraTwin®

Design surfaces

Design

glazed

Cement

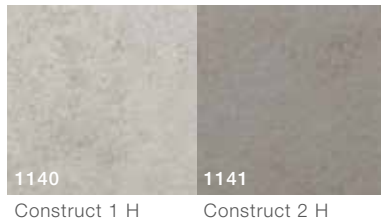

Metal

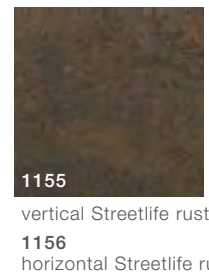
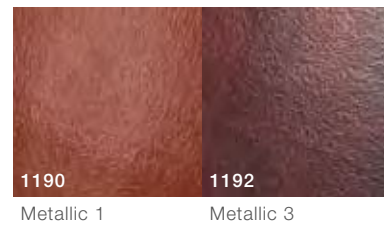

Wood

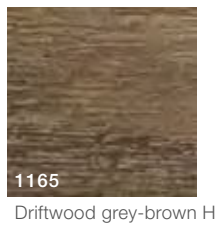
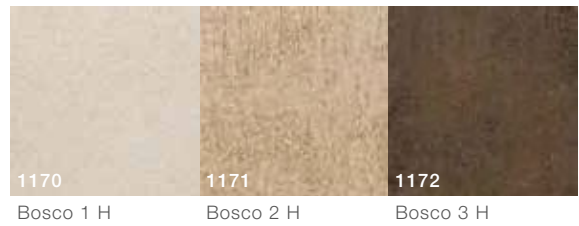
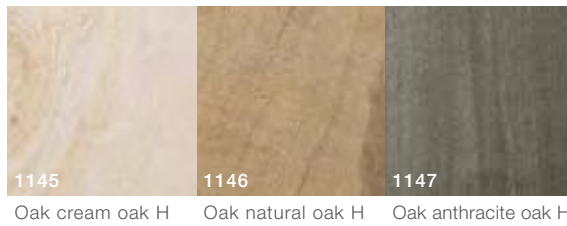

KeraTwin® panels have the Hytect surface.

In addition to the variants shown, the production of individual articles is also possible. After a short check of the individual case for technical and economical feasibility, we will be pleased to provide you with project-specific information.

H = Hytect surface

Design

unglazed



The surfaces Design unglazed are optionally available without Hytect.





ADDED
VALUE FOR
PEOPLE,
BUILDINGS
AND CITIES

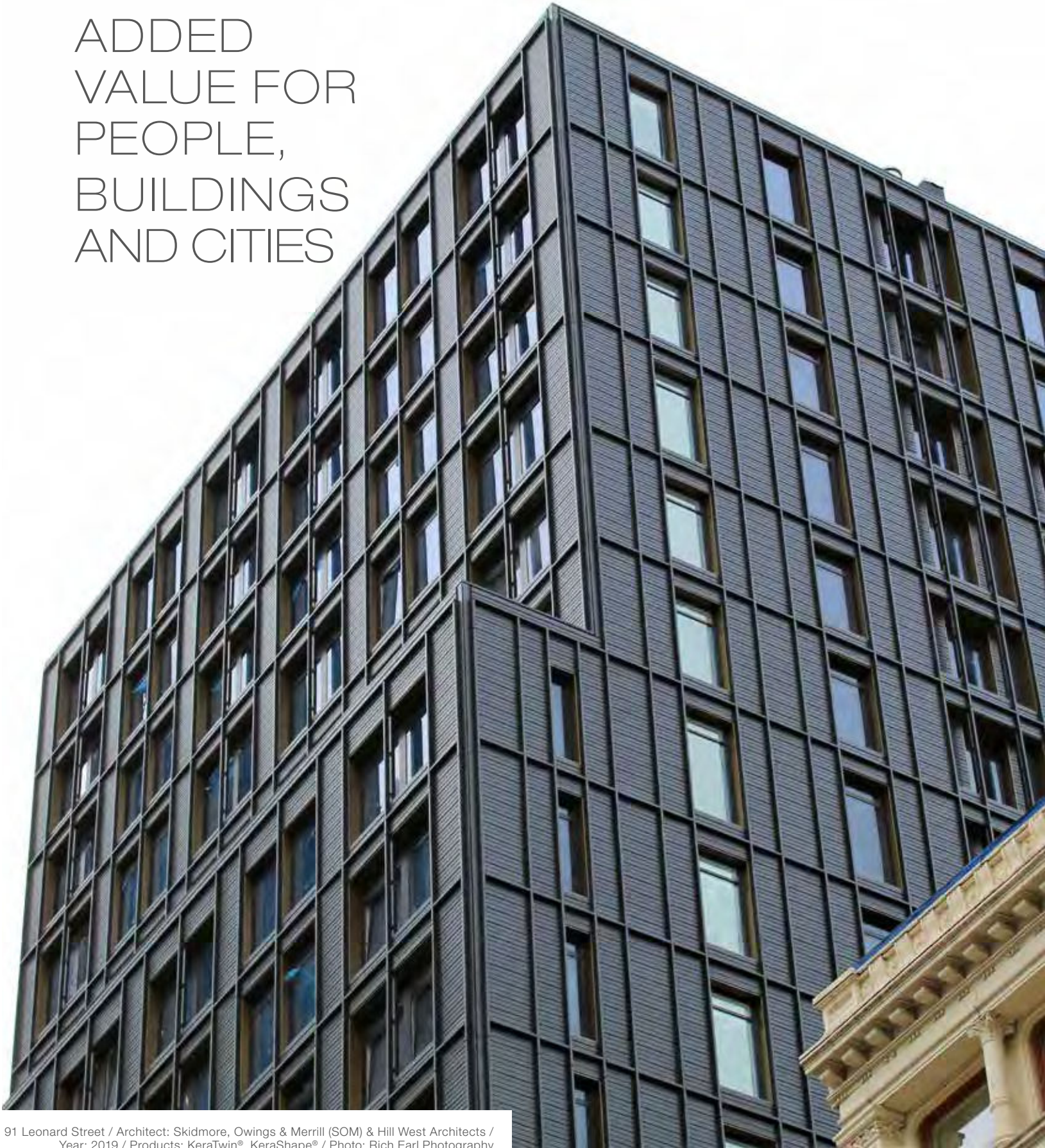

91 Leonard Street / Architect: Skidmore, Owings & Merrill (SOM) & Hill West Architects /
Year: 2019 / Products: KeraTwin®, KeraShape® / Photo: Rich Earl Photography

For everlasting beautiful facades

Hytect ceramics is sustainable, economical and efficient on facades. Among other things, because Hytect facades basically clean themselves.

The self-washing effect of Hytect facades has a long-term effect in terms of costs. However, it also increases the visual attractiveness of buildings – because they are simply always clean. Just as important: Hytect facades are almost indestructible. They are easy to install and can be combined with various types of thermal insulation. All this makes their use financially attractive and sustainable for the environment. Rain and moisture usually have a negative effect on conventional facades. In the case of Hytect facades, the opposite is true. Because when it rains on them, the natural self-washing effect of Hytect starts. Dirt is infiltrated and simply washed away by the rain. By photocatalysis, a particularly great amount of active oxygen is produced on the surface of the ceramics. Moss, algae, fungi etc. are thus prevented from growing on the facade. This also saves cleaning costs. In addition, Hytect facades are resistant to frost, wind and weather. Because they are practically indestructible. Renovations thus become superfluous – and the economic efficiency increases.

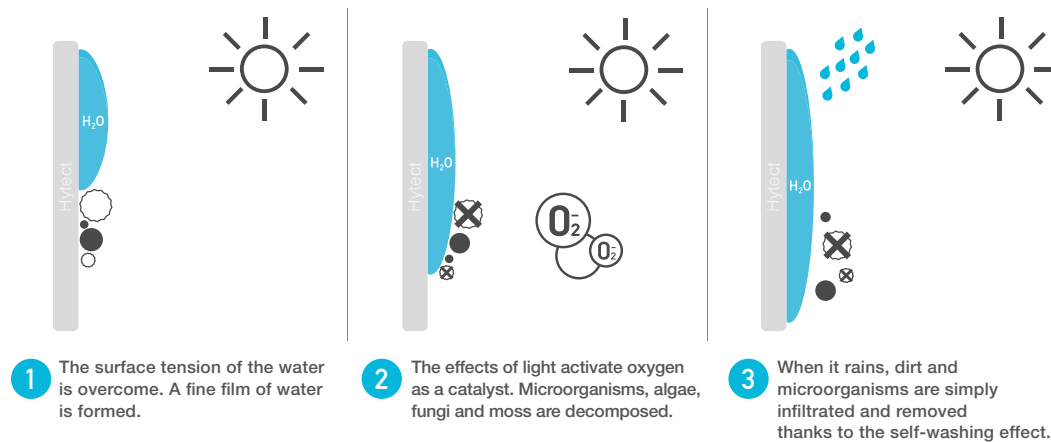

This is how the self-washing effect* of Hytect works: when it rains, a thin water film forms on the surface of the Hytect ceramics, which infiltrates dirt and finest dust particles

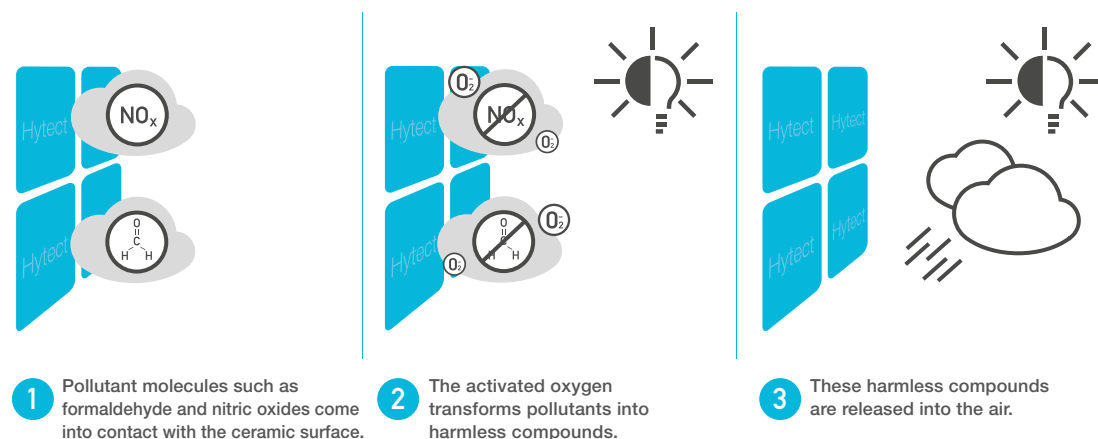

By photocatalysis, a particularly great amount of active oxygen is produced on the surface of the ceramics. Moss, algae, fungi etc. are thus prevented from growing on the facade.

The Hytect technology helps to keep facades and surfaces clean. In addition, they are very resistant. Graffiti can be easily removed with appropriate means without leaving any damage to the surface. All glazed facade panels of AGROB BUCHTAL are provided with Hytect surfaces as standard.

* for glazed panels



A clean solution for cities and people

Facades can also contribute a lot to make our cities cleaner.

Hytect neutralizes nitrogen to a degree which should not be underestimated. We checked that again, and we found out that 1,000 m² of Hytect facade neutralize approximately the NO_x emissions of a Euro 5 car over a distance of 10,000 kilometres every year. By the way, we Germans drive our car 35 kilometres a day on average. Thus, the facade neutralizes the average daily drives of around 286 persons in Germany – of course again in Euro 5 vehicles. If one calculates with the newer Euro 6 vehicles, the distance even increases to 22,000 kilometres – or the daily drives of 628 persons. Thus, Hytect facades indeed can be a contribution to sustainably improving the air quality in cities. They definitely also are a contribution which benefits the environment. Because Hytect facades rarely have to be cleaned. This also helps to protect the environment, because the use of chemical agents or electrically operated cleaning equipment simply is not necessary.

We have done the math

1,000 m² of Hytect facade neutralize the NO_x of 1,000 driven distances of 10 km per year.

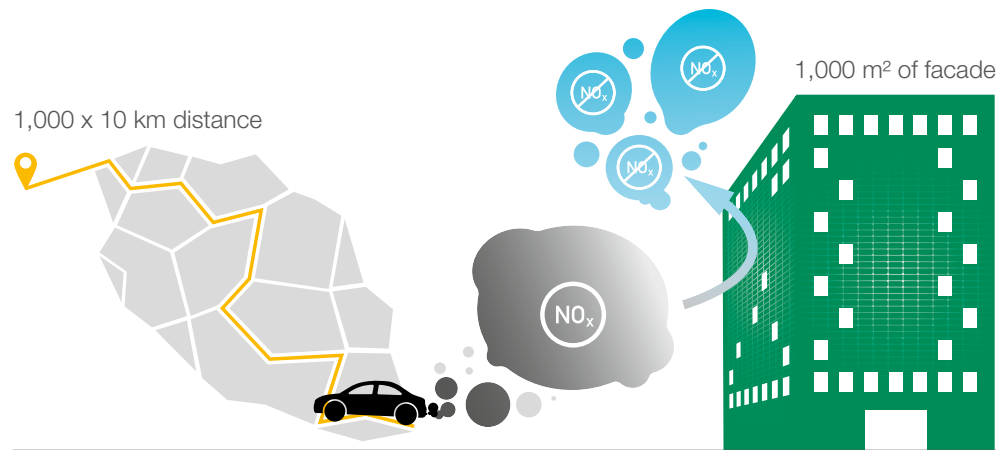

NO_x reduction Hytect

Emission standard – diesel vehicle	EURO 3	EURO 4	EURO 5	EURO 6	
Reduction rate Hytect	0.4	0.4	0.4	0.4	mg / m ² hour
Active time 1	12	12	12	12	Hours / day (lightness)
Active time 2	7	7	7	7	Days / week
Active time 3	52	52	52	52	Weeks / year
Surface	1,000	1,000	1,000	1,000	m ²
emission NO _x	500	250	180	80	mg / km
Equivalent in km	3,000	7,000	10,000	2,000	km / year
Distances	300	700	1,000	2,200	à 10 km



Main fire station Regensburg, Germany / Architect: Diezinger Architekten /
Year: 2019 / Product: KeraTwin® / Photo: Atelier Bürger



Ceramic facade systems for sustainable renovation

The world-wide trend towards urbanization is unbroken. New city dwellers need housing space, but areas for new buildings are hardly available. That is why densification and modernization have been gaining importance for years. In this situation, ceramic facade systems offer decisive advantages.

The renovation of existing buildings opens up new opportunities for future-oriented urban planning: previously neglected districts are becoming attractive living areas, and after energy-efficient renovation, even historical buildings meet the increased demands made on the energy balance. For this reason, the renovations already exceed the volume of new buildings in many places. A sustainable solution with energy-efficient and aesthetic advantages is offered by ceramic facade systems, which are applied to the old facade like a second shell. In this way, different energy-saving requirements can be met, because the space between the old and the new facade provides space for insulation layers of any thickness. In addition, curtain-type facades create ideal conditions for the visual enhancement of buildings, because they also allow a building grid which is independent of the original building fabric. And the positive effects on the quality of living also speak for this form of renovation. Because the decoupling of the outer skin from the building body keeps the living spaces cool in summer and warm in winter.

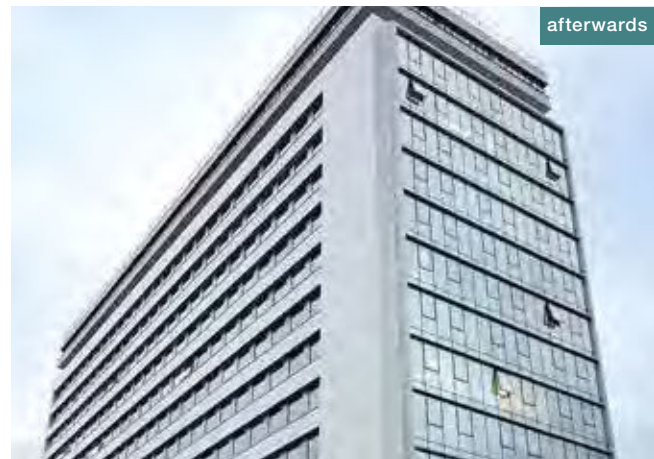
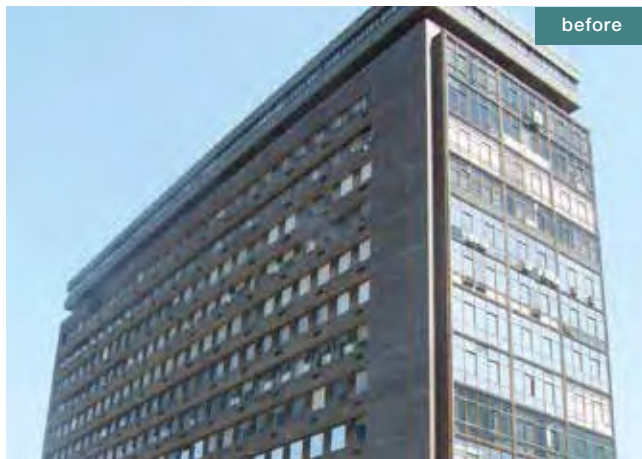

Edificio Albia, Bilbao, Spain / Architect: Estudio de Arquitectura y Urbanismo SG2A, Bilbao, Spain / Product: KeraTwin® / Photo: Lorenzo Rimondi

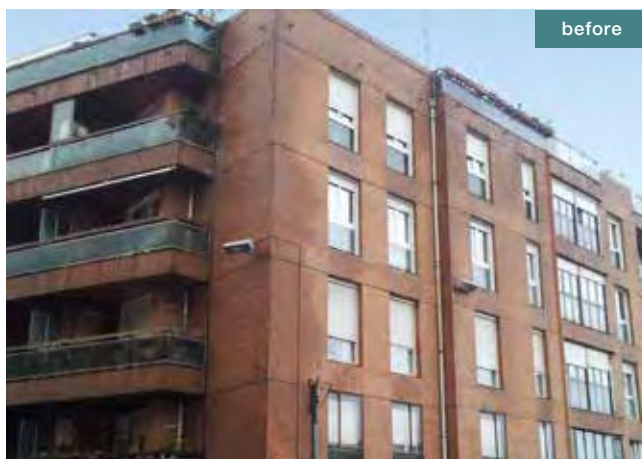

Residential building c/Juan Bautista Uribarri, Bilbao, Spain / Year: 2015 / Product: KeraTwin®



Pharmacy Sciarretta, Castelliri, Italy / Architect: Stefano Russo / Product: KeraTwin® / Photo: Lorenzo Rimondi

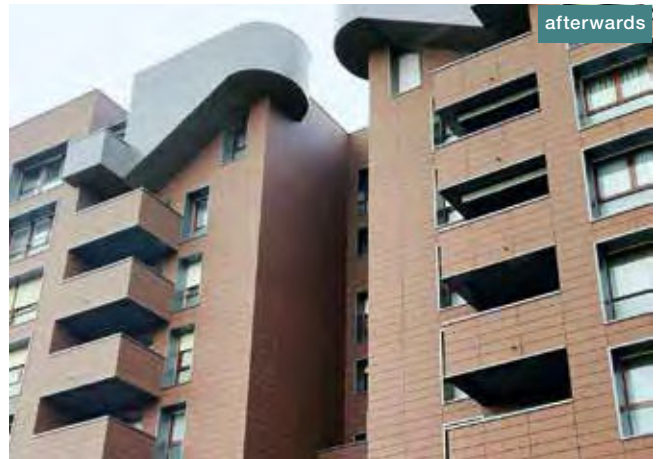

San Ignacio 8, Durango (Vizcaya), Spain / Architect: Maab Arquitectura, Bilbao, Spain / Product: KeraTwin® / Photo: Joaquin Prat

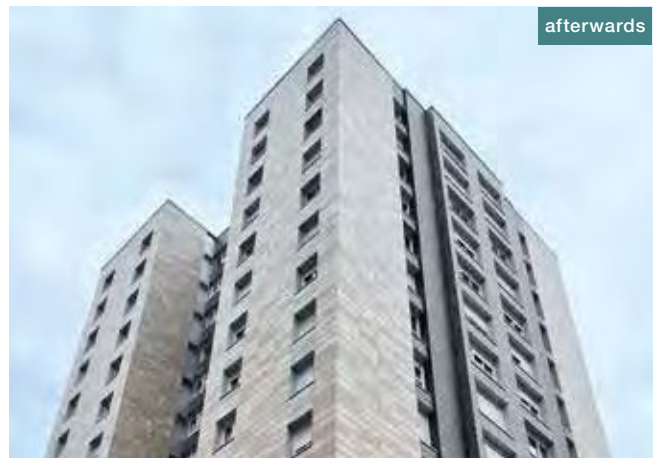
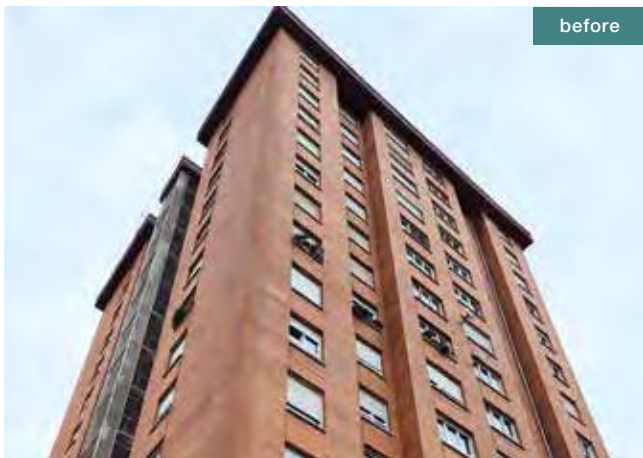

Puerto Ventana, Gijon, Spain / Product: KeraTwin® / Photo: Joaquin Prat

AGROB BUCHTAL GmbH
Buchtal 1, 92521 Schwarzenfeld, Germany
Phone: +49 (0) 94 35-391-0
Fax: +49 (0) 94 35-391-34 52

Servaisstraße, 53347 Alfter-Witterschlick, Germany
Phone: +49 (0) 228-391-0
Fax: +49 (0) 228-391-1273

E-Mail info@agrob-buchtal.de
Internet www.agrob-buchtal.de

